

# JSL

Material Eléctrico

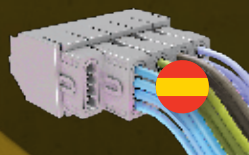

## TABLA DE PRECIOS 2023-2024

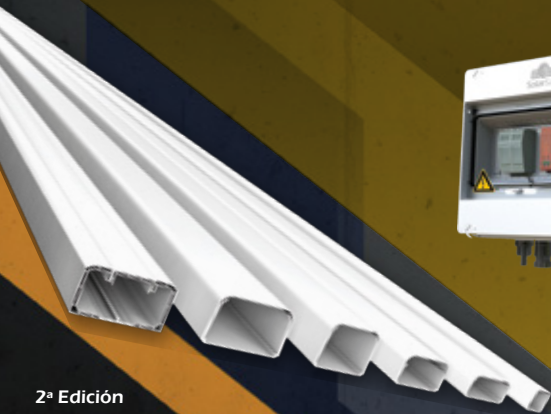
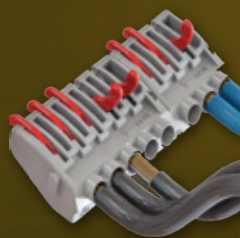
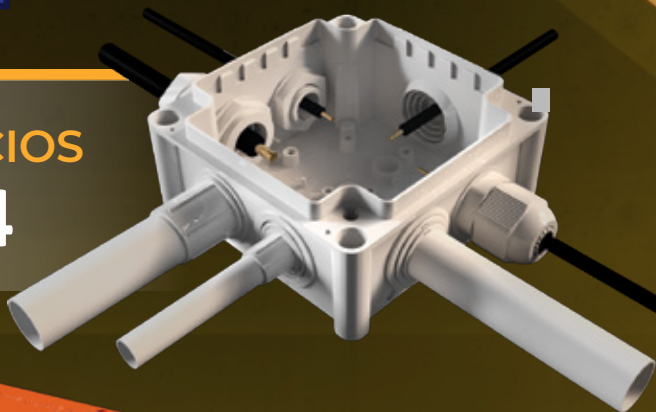



## PROTEGER SU INVERSIÓN

Estos equipos se basan en paneles de células fotovoltaicas (PV) e inversores de corriente. Las células utilizan la energía solar para convertir los fotones luminosos en Corriente Directa (DC). La electricidad generada por las células solares alimenta así a un inversor que regula y convierte la corriente continua en corriente alterna.

### DIAGRAMA

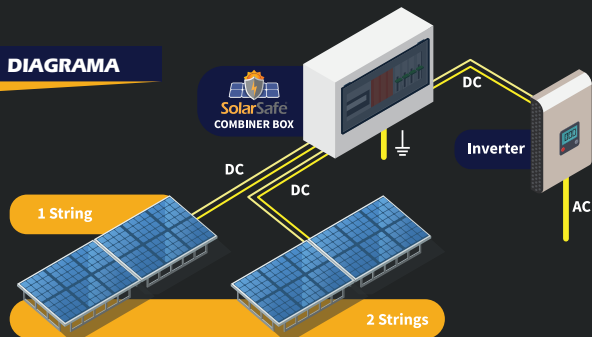

La energía generada en Corriente Alterna puede ser utilizada localmente por un equipo específico, una vivienda o ser conectada directamente a la red y así ser utilizada como energía limpia, protegiendo el medio ambiente.



Ref.	Descripción	Dimensiones (mm)	Precio Tab. Uni.	Unid. Med.	Cant. Mín. Prov.
<b>SOLARSAFE - COMBINER BOX</b>					
<b>CBS-SL7</b>	Caja de protección combinada PV SOLARSAFE con interruptor dc 7-PV (1 string)	220x170x120	278,00	Un	1
<b>CBS-SISO</b>	Caja de protección combinada PV SOLARSAFE con interruptor DC SISO-Z (1 String)	220x170x120	278,00	Un	1
<b>CBS-SL7-II</b>	Caja de protección combinada PV SOLARSAFE ccon interruptor DC SL7-PV (2 Strings)	220x170x120	315,00	Un	1
<b>CBS-SISO-II</b>	Caja de protección combinada PV SOLARSAFE con interruptor DC SISO-Z (2 Strings)	220x170x120	315,00	Un	1

HF	Ref.	Descripción	Dimensiones (mm)	Precio Tab. Uni.	Unid. Med.	Cant. Mín. Prov.
<b>CAJA DE SUELO</b>						
	<b>745-8C</b>	Caja De Suelo 8 Mod Gris C/Chapa	250x250x58	97,65	Un	1
	<b>745-8SC</b>	Caja De Suelo 8 Mod Gris S/Chapa	250x250x58	87,15	Un	1
	<b>745-4C</b>	Caja De Suelo 4 Mod Gris C/Chapa	250x145x58	66,15	Un	1
	<b>745-4SC</b>	Caja De Suelo 4 Mod Gris S/Chapa	250x145x58	57,75	Un	1
<b>ACCESORIOS PARA CAJA DE SUELO</b>						
	<b>CFR748</b>	Registro Para Hormigon	-	8,40	Un	1
	<b>EPS8M</b>	Bloque De Poliestireno p/caja de 8	-	5,775	Un	1
	<b>EPS4M</b>	Bloque De Poliestireno p/caja de 4	-	4,41	Un	1
	<b>758</b>	Placa Metálica 8 Modulos	220x190	11,03	Un	1
	<b>754</b>	Placa Metálica 4 Modulos	220x85	8,82	Un	1
<b>TORRE DE SUELO</b>						
	<b>TR7018</b>	Torre De Suelo Completa TR	-	23,10	Un	1
<b>ACCESORIOS PARA TORRE DE SUELO</b>						
	<b>CR7018</b>	Corpo da torre 2 lados	-	7,88	Un	1
<b>TOMA DE CARGAMENTO POWERTOWER</b>						
	<b>PWT</b>	Power Tower - 3 Tomas Schuko + 2 Usb	-	76,65	Un	1
<b>CAJAS PARA INSTALACIÓN INTERIOR (Caja Superficie)</b>						
	<b>CS245</b>	Caja Superficie Para 2 Módulos (45x45)	142x71x62	17,12	Un	1
	<b>CS445</b>	Caja Superficie Para 4 Módulos (45x45)	142x142x62	26,25	Un	1
	<b>CS645</b>	Caja Superficie Para 6 Módulos (45x45)	142x213x62	36,75	Un	1
<b>CAJAS PARA INSTALACIÓN INTERIOR (Caja Empotrar)</b>						
	<b>CE245</b>	Caja Empotrar Para 2 Modulos (45x45)	135x55x64	20,16	Un	1
	<b>CE445</b>	Caja Empotrar Para 4 Modulos (45x45)	135x55x134	28,88	Un	1
	<b>CE645</b>	Caja Empotrar Para 6 Modulos (45x45)	135x55x206	39,90	Un	1
<b>ACCESORIOS PARA IZI BOXLINE</b>						
	<b>745 IS-L</b>	Accesorio Para 2 Elementos Modulo	50x120x10	5,25	Un	6
	<b>745-2SK</b>	Para Toma dupla SCHUKO	50x120x10	5,25	Un	3
	<b>DIS-L</b>	Accesorio Para Magnetotérmico Con Tapa	50x120x35	13,65	Un	2
	<b>745-CD</b>	Tecla Ciega 90x45	90x45	5,25	Un	10
	<b>745-C</b>	Tecla Ciega 45x45	45x45	1,10	Un	10
	<b>745-MC</b>	Tecla Ciega 1/2 45x45	22,5x45	0,69	Un	10

			Compatibilidad	Ref.	Dimensiones (mm)	Precio Tab. Uni.	Unid. Med.	Cant. Mín. Prov.
<b>HF</b> CANALETA ADHESIVAS CON TAPA LIBRES DE HALOGENEO			<b>ADESIVA</b>					
			<b>2012,5BADLH</b>	20x12.5	5,04	Mt.	70	
			<b>2020BADLH</b>	20x20	6,83	Mt.	50	
<b>HF</b> CANALETA CON TAPA LIBRES DE HALOGENEO			<b>ADESIVA</b>					
			<b>2012,5BLH</b>	20x12.5	4,41	Mt.	80	
			<b>2020BLH</b>	20x20	6,20	Mt.	50	
			<b>4017BLH</b>	40x17	8,80	Mt.	30	
			<b>4040 BLH</b>	40x40	11,20	Mt.	46	
			<b>6040BLH</b>	60x40	20,48	Mt.	32	
			<b>10054BLH</b>	100x54	29,40	Mt.	12	
<b>CANALETA ADHESIVAS CON TAPA</b>			<b>ADESIVA</b>					
				<b>1207BAD</b>	12x7	1,34	Mt.	160
				<b>1610BAD</b>	16x10	1,76	Mt.	90
				<b>1517BAD</b>	15x17	2,34	Mt.	60
				<b>2010BAD</b>	20x10	2,02	Mt.	80
				<b>2012,5BAD</b>	20x12,5	2,02	Mt.	70
				<b>2517BAD</b>	25x17	2,57	Mt.	40
				<b>2020BAD</b>	20x20	2,28	Mt.	50
				<b>3010BAD</b>	30x10	3,03	Mt.	50
				<b>4017BAD</b>	40x17	3,92	Mt.	30
<b>CANALETA CON TAPA</b>			<b>ADESIVA</b>					
				<b>1207B</b>	12x7	0,83	Mt.	180
				<b>1610B</b>	16x10	1,12	Mt.	100
				<b>1517B</b>	15x17	1,49	Mt.	60
				<b>2010B</b>	20x10	1,34	Mt.	80
				<b>2012,5B</b>	20x12,5	1,34	Mt.	80
				<b>2020B</b>	20x20	1,60	Mt.	50
				<b>2517B</b>	25x17	1,88	Mt.	50
				<b>2525B</b>	25x25	2,29	Mt.	80
				<b>3010B</b>	30x10	1,82	Mt.	50
				<b>4017B</b>	40x17	2,68	Mt.	30
				<b>4040B</b>	40x40	3,70	Mt.	46
				<b>6040B</b>	60x40	5,51	Mt.	32
				<b>8040B</b>	80x40	7,52	Mt.	24
				<b>10040B</b>	100x40	10,23	Mt.	16
				<b>10054B</b>	100x54	10,48	Mt.	12



HF

Ref.	Dimensiones (mm)	Precio Tab. Uni.	Unid. Med.	Cant. Mín. Prov.
<b>ANGULO EXTERIOR</b>				
<b>AE1207B</b>	12x7	0,63	Un.	50
<b>AE1610B</b>	16x10	0,63	Un.	50
<b>AE1517B</b>	15x15	0,63	Un.	50
<b>AE2010B</b>	20x10	0,63	Un.	50
<b>AE2012,5B</b>	20x12,5	0,63	Un.	50
<b>AE2517B</b>	25x17	0,66	Un.	50
<b>AE2525B</b>	25x25	0,88	Un.	50
<b>AE3010B</b>	30x10	0,66	Un.	50
<b>AE4017B</b>	40x17	0,88	Un.	50
<b>AE4040B</b>	40x40	1,18	Un.	50
<b>AE6040B</b>	60x40	1,46	Un.	10
<b>AE8040B</b>	80x40	1,84	Un.	10
<b>AE10040B</b>	100x40	3,31	Un.	10
<b>AE10054B</b>	100x54	3,50	Un.	6
<b>ANGULO INTERIOR</b>				
<b>AI1207B</b>	12x7	0,63	Un.	50
<b>AI1610B</b>	16x10	0,63	Un.	50
<b>AI1517B</b>	15x17	0,63	Un.	50
<b>AI2010B</b>	20x10	0,63	Un.	50
<b>AI2012,5B</b>	20x12,5	0,63	Un.	50
<b>AI2517B</b>	2x17	0,66	Un.	50
<b>AI2525B</b>	25x25	0,88	Un.	50
<b>AI3010B</b>	30x10	0,66	Un.	50
<b>AI4017B</b>	40x17	0,88	Un.	50
<b>AI4040B</b>	40x40	1,18	Un.	50
<b>AI6040B</b>	60x40	1,46	Un.	10
<b>AI8040B</b>	80x40	1,84	Un.	10
<b>AI10040B</b>	100x40	3,31	Un.	10
<b>AI10054B</b>	100x54	3,50	Un.	6

HF

Ref.	Dimensiones (mm)	Precio Tab. Uni.	Unid. Med.	Cant. Mín. Prov.
<b>ANGULO PLANO</b>				
<b>AP1207B</b>	12x07	0,63	Un.	50
<b>AP1610B</b>	16x10	0,63	Un.	50
<b>AP1517B</b>	15x17	0,63	Un.	50
<b>AP2010B</b>	20x10	0,63	Un.	50
<b>AP2012,5B</b>	20x12,5	0,63	Un.	50
<b>AP2517B</b>	25x17	0,66	Un.	50
<b>AP2525B</b>	25x25	0,88	Un.	50
<b>AP3010B</b>	30x10	0,66	Un.	50
<b>AP4017B</b>	40x17	0,88	Un.	50
<b>AP4040B</b>	40x40	1,18	Un.	25
<b>AP6040B</b>	60x40	1,46	Un.	10
<b>AP8040B</b>	80x40	1,84	Un.	10
<b>AP10040B</b>	100x40	3,31	Un.	10
<b>AP10054B</b>	100x54	3,50	Un.	6
<b>DERIVACION T</b>				
<b>GT1207B</b>	12x07	0,63	Un.	50
<b>GT1610B</b>	16x10	0,63	Un.	50
<b>GT1517B</b>	15x17	0,63	Un.	50
<b>GT2010B</b>	20x10	0,63	Un.	50
<b>GT2012,5B</b>	20x12,5	0,63	Un.	50
<b>GT2517B</b>	25x17	0,66	Un.	50
<b>GT2525B</b>	25x25	0,88	Un.	50
<b>GT3010B</b>	30x10	0,66	Un.	50
<b>GT4017B</b>	40x17	0,88	Un.	50
<b>GT4040B</b>	40x40	1,12	Un.	25
<b>GT6040B</b>	60x40	1,39	Un.	10
<b>GT8040B</b>	80x40	1,75	Un.	10
<b>GT10040B</b>	100x40	3,31	Un.	10
<b>GT10054B</b>	100x54	3,50	Un.	6

HF



Ref.	Dimensiones (mm)	Precio Tab. Uni.	Unid. Med.	Cant. Mín. Prov.
<b>UNION</b>				
<b>GU1207B</b>	12x07	0,59	Un.	50
<b>GU1610B</b>	16x10	0,59	Un.	50
<b>GU1517B</b>	15x17	0,59	Un.	50
<b>GU2010B</b>	20x10	0,59	Un.	50
<b>GU2012,5B</b>	20x12.5	0,59	Un.	50
<b>GU2517B</b>	25x17	0,61	Un.	50
<b>GU2525B</b>	25x25	0,83	Un.	50
<b>GU3010B</b>	30x10	0,61	Un.	50
<b>GU4017B</b>	40x17	0,83	Un.	50
<b>GU4040B</b>	40x40	0,97	Un.	50
<b>GU6040B</b>	60x40	1,18	Un.	10
<b>GU8040B</b>	80x40	1,47	Un.	10
<b>GU10040B</b>	100x40	1,58	Un.	10
<b>GU10054B</b>	100x54	1,75	Un.	10
<b>TAPA FINAL</b>				
<b>TT1207B</b>	12x07	0,59	Un.	50
<b>TT1610B</b>	16x10	0,59	Un.	50
<b>TT1517B</b>	15x17	0,59	Un.	50
<b>TT2010B</b>	20x10	0,59	Un.	50
<b>TT2012,5B</b>	20x12.5	0,59	Un.	50
<b>TT2517B</b>	25x17	0,61	Un.	50
<b>TT2525B</b>	25x25	0,83	Un.	50
<b>TT3010B</b>	30x10	0,61	Un.	50
<b>TT4017B</b>	40x17	0,83	Un.	50
<b>TT4040B</b>	40x40	0,97	Un.	50
<b>TT6040B</b>	60x40	1,18	Un.	10
<b>TT8040B</b>	80x40	1,47	Un.	10
<b>TT10040B</b>	100x40	1,66	Un.	10
<b>TT10054B</b>	100x54	1,75	Un.	10



HF



Ref.	Dimensiones (mm)	Precio Tab. Uni.	Unid. Med.	Cant. Mín. Prov.
<b>ACCESORIOS PARA CANALETA INWAY</b>				

**45IN10** - 2,81 Un. 10

**45IN10D** - 5,51 Un. 5

**45IN17** - 2,81 Un. 10

**45IN17D** - 5,51 Un. 5

**80INS** - 1,44 Un. 10

**80INT** - 2,81 Un. 5

**S8040** - 1,47 Un. 100

**S10040** - 1,47 Un. 70

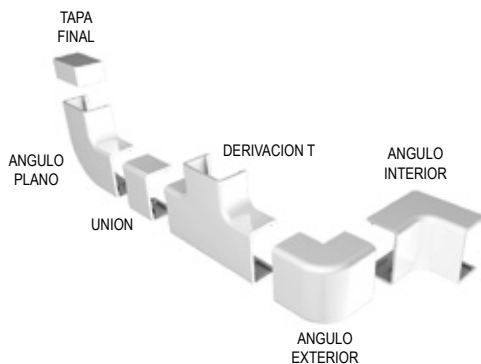

CANALETAS PARA TUBERÍA



Ref.	Dimensiones (mm)	Precio Tab. Uni.	Unid. Med.	Cant. Mín. Prov.
<b>T3535</b>	35x35	2,45	Mt.	68
<b>T7040</b>	70x40	3,76	Mt.	36
<b>T7040-PLUS</b>	70x40	3,76	Mt.	32
<b>T7060</b>	70x60	5,78	Mt.	24
<b>T10060</b>	100x60	7,17	Mt.	12

BASES PUERTA TUBOS Y CABLES PARA CANALETAS FLUIDLINE



<b>B7040 *</b>	70x40	3,15	Mt.	36
<b>B7060</b>	70x60	4,90	Mt.	24
<b>B10060</b>	100x60	5,95	Mt.	12

\* La base B7040 es compatible con las canaletas T7040 y T7040-PLUS

ACCESORIOS **fluidline**

HF



Ref.	Dimensiones (mm)	Precio Tab. Uni.	Unid. Med.	Cant. Mín. Prov.
------	------------------	------------------	------------	------------------

ANGULO EXTERIOR

<b>AE3535</b>	35x35	1,23	Un.	10
---------------	-------	------	-----	----



ANGULO INTERIOR

<b>AI3535</b>	35x35	1,23	Un.	10
---------------	-------	------	-----	----



ANGULO PLANO

<b>AP3535</b>	35x35	1,23	Un.	10
---------------	-------	------	-----	----



DERIVACION T

<b>GT3535</b>	35x35	1,23	Un.	10
---------------	-------	------	-----	----



UNION

<b>GU3535</b>	35x35	0,92	Un.	10
---------------	-------	------	-----	----



TAPA FINAL

<b>TT3535</b>	35x35	0,92	Un.	10
---------------	-------	------	-----	----



REDUTOR

<b>RT10040F</b>	-	2,97	Un.	5
-----------------	---	------	-----	---



DERIVACION EN T PARA CURVA DE AGUA

<b>GT7040E1</b>	-	2,63	Un.	5
-----------------	---	------	-----	---

HF



Ref.	Dimensiones (mm)	Precio Tab. Uni.	Unid. Med.	Cant. Mín. Prov.
------	------------------	------------------	------------	------------------

ACCESORIOS PARA CANALETA FLUIDLINE

<b>4014</b>	35x35x28	0,74	Un.	50
-------------	----------	------	-----	----

<b>4015</b>	70/100x40x30	1,13	Un.	25
-------------	--------------	------	-----	----

CAJA EMP. PRE-INSTALACION AIRE ACOND.

<b>4011</b>	-	7,28	Un.	24
-------------	---	------	-----	----

<b>4012</b>	-	5,46	Un.	17
-------------	---	------	-----	----



<b>4013</b>	-	1,82	Un.	20
-------------	---	------	-----	----



ACCESORIOS DE PRE-INSTALACION AIRE ACOND.

<b>4018</b>	-	1,00	Un.	50
-------------	---	------	-----	----

<b>4019</b>	-	1,91	Un.	50
-------------	---	------	-----	----

<b>4020</b>	-	0,40	Un.	50
-------------	---	------	-----	----

HF	Ref.	Dimensiones (mm)	Precio Tab. Uni.	Unid. Med.	Cant. Mín. Prov.
	<b>ANGULO EXTERIOR</b>				
	<b>AE7040</b>	70x40	2,28	Un.	10
	<b>AE7040-P</b>	70x40	2,28	Un.	10
	<b>AE7060</b>	70x60	2,45	Un.	10
	<b>AE10060</b>	100x60	3,12	Un.	10
	<b>ANGULO INTERIOR</b>				
	<b>AI7040</b>	70x40	2,28	Un.	10
	<b>AI7040-P</b>	70x40	2,28	Un.	10
	<b>AI7060</b>	70x60	2,45	Un.	10
	<b>AI10060</b>	100x60	2,97	Un.	5
	<b>ANGULO PLANO</b>				
	<b>AP7040</b>	70x40	2,28	Un.	10
	<b>AP7040-P</b>	70x40	2,28	Un.	10
	<b>AP7060</b>	70x60	2,45	Un.	10
	<b>AP10060</b>	100x60	2,97	Un.	5

HF	Ref.	Dimensiones (mm)	Precio Tab. Uni.	Unid. Med.	Cant. Mín. Prov.
	<b>DERIVACION T</b>				
	<b>GT7040</b>	70x40	2,39	Un.	10
	<b>GT7040-P</b>	70x40	2,28	Un.	10
	<b>GT7060</b>	70x60	2,45	Un.	10
	<b>GT10060</b>	100x60	2,97	Un.	5
	<b>UNION</b>				
	<b>GU7040</b>	70x40	1,12	Un.	10
	<b>GU7040-P</b>	70x40	1,12	Un.	10
	<b>GU7060</b>	70x60	1,23	Un.	10
	<b>GU10060</b>	100x60	2,28	Un.	5
	<b>TAPA FINAL</b>				
	<b>TT7040</b>	70x40	1,12	Un.	10
	<b>TT7040-P</b>	70x40	1,12	Un.	10
	<b>TT7060</b>	70x60	1,23	Un.	10
	<b>TT10060</b>	100x60	2,28	Un.	5

## CANALETAS



## CANALETAS DE CANTOS ARREDONDADOS ROUNDWAY

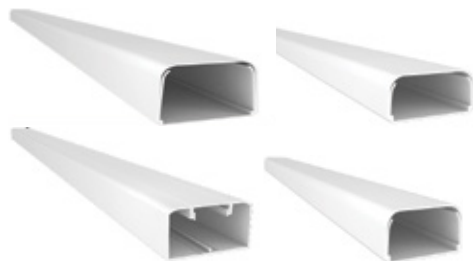

Ref.	Dimensiones (mm)	Precio Tab. Uni.	Unid. Med.	Cant. Mín. Prov.
<b>B7040 + T7040</b>	70x40	3,15+3,76	Mt.	36+36
<b>B7040 + T7040-PLUS</b>	70x40	3,15+3,76	Mt.	36+32
<b>B7060 + T7060</b>	70x60	4,90+5,78	Mt.	24+24
<b>10054B</b>	100x54	10,48	Mt.	12
<b>B10060 + T10060</b>	100x60	5,95+7,17	Mt.	12+12

Ref.	Dimensiones (mm)	Precio Tab. Uni.	Unid. Med.	Cant. Mín. Prov.
<b>CANALETA DE RODAPIE</b>				



<b>7020B</b>	70x20	5,63	Mt.	32
--------------	-------	------	-----	----

HF

**ACCESORIOS PARA CANALETA RODAPIE**



<b>873-IN20</b>	-	5,83	Un.	5
-----------------	---	------	-----	---



<b>873-TC20</b>	-	7,83	Un.	2
-----------------	---	------	-----	---



HF

Ref.	Dimensiones (mm)	Precio Tab. Uni.	Unid. Med.	Cant. Mín. Prov.
<b>ANGULO EXTERIOR</b>				
<b>AE7020B</b>	70x20	1,66	Un.	10
<b>ANGULO INTERIOR</b>				
<b>AI7020B</b>	70x20	1,66	Un.	10
<b>ANGULO PLANO</b>				
<b>AP7020B</b>	70x20	1,66	Un.	10
<b>DERIVACION T</b>				
<b>GT7020B</b>	70x20	1,66	Un.	10
<b>UNION</b>				
<b>GU7020B</b>	70x20	1,29	Un.	10
<b>TAPA FINAL</b>				
<b>TT7020B</b>	70x20	1,29	Un.	10



**CANALETA DE SUELO Y ACCESORIOS**



Ref.	Dimensiones (mm)	Precio Tab. Uni.	Unid. Med.	Cant. Mín. Prov.
<b>CANALETA DE SUELO</b>				



<b>7018</b>	70x18	5,32	Mt.	20
-------------	-------	------	-----	----

HF

**ACCESORIOS PARA CANALETA DE SUELO**



<b>GR7018</b>	-	15,23	Un.	1
---------------	---	-------	-----	---

HF

Ref.	Dimensiones (mm)	Precio Tab. Uni.	Unid. Med.	Cant. Mín. Prov.
<b>ANGULO PLANO</b>				
<b>GU7018</b>	-	1,29	Un.	25
<b>ADAPTADOR PARA CANALETA</b>				
<b>AD7020</b>	-	1,66	Un.	10
<b>UNION</b>				
<b>AP7018</b>	-	1,66	Un.	10





HF



Ref.	Descrição	Preço Tab. Uni.	Unid. Med.	Qt. Mín. Forn.
F21-C3	Toma Dupla Usb De Carga Rápida 5V 2.1A	31,50	Un.	2
745-LAN-ANG	Toma Rj45 Doble angular P/Canal	8,05	Un.	10
745-AMP-ANG	Espejo RJ45 doble angular	1,58	Un.	10
745-LAN	Toma Rj45 Doble liso P/Canal	8,05	Un.	10
745-AMP	Espejo RJ45 doble liso	1,58	Un.	10
745-T-BR	Toma Schuko P/Canal 16A/250V 2P+T (Blanco)	3,20	Un.	10
745-T-EN	Toma Schuko P/Canal 16A/250V 2P+T (Rojo)	3,20	Un.	10
745-F-BR	Toma Schuko Franc. 16A/250V 2P+T (Blanco)	3,20	Un.	10
745-F-EN	Tomada Schuko Franc. 16A/250V 2P+T (Rojo)	3,20	Un.	10
745-TV	Toma TV/SAT. 1 modulo 45x45	3,78	Un.	10
745-TVM	Toma TV/SAT. 1/2 modulo 25x45	3,11	Un.	10
745-C	Tecla Ciega 45x45	1,10	Un.	10
745-MC	1/2 Tecla Ciega	0,69	Un.	10
484	Toma exterior	2,00	Un.	10
483-T	Toma exterior con tierra	3,63	Un.	10

HF



Ref.	Descripción	Precio Tab. Uni.	Unid. Med.	Cant. Mín. Prov.
<b>JSA3093</b>	Caja estanca industrial de potencia con 2 tomas schuko de 16A/250V	21,00	Un.	1



Ref.	Polos	Amp.	IP	IK	Precio Tab. Uni.	Unid. Med.	Cant. Mín. Prov.
<b>CLAVIJAS - IP44</b>							
<b>9316/4</b>	2P+T	16	44	09	5,29	Un.	10
<b>9416/4</b>	3P+T	16	44	09	5,72	Un.	10
<b>9516/4</b>	3P+N+T	16	44	09	6,54	Un.	10
<b>9332/4</b>	2P+T	16	44	09	7,38	Un.	10
<b>9432/4</b>	3P+T	32	44	09	8,35	Un.	10
<b>9532/4</b>	3P+N+T	32	44	09	9,32	Un.	10

**PROLONGADORES IP44**

<b>9316/3</b>	2P+T	32	44	09	6,74	Un.	10
<b>9416/3</b>	3P+T	16	44	09	7,97	Un.	10
<b>9516/3</b>	3P+N+T	16	44	09	9,16	Un.	10
<b>9332/3</b>	2P+T	32	44	09	9,23	Un.	10
<b>9432/3</b>	3P+T	32	44	09	10,05	Un.	10
<b>9532/3</b>	3P+N+T	32	44	09	11,54	Un.	10

**BASES MURALES - IP44**

<b>9316/2N</b>	2P+T	16	44	09	7,90	Un.	10
<b>9416/2N</b>	3P+T	16	44	09	7,98	Un.	10
<b>9516/2N</b>	3P+N+T	16	44	09	8,56	Un.	10
<b>9332/2N</b>	2P+T	32	44	09	11,07	Un.	10
<b>9432/2N</b>	3P+T	32	44	09	11,55	Un.	10
<b>9532/2N</b>	3P+N+T	32	44	09	12,80	Un.	10
<b>9316/2</b>	2P+T	16	44	09	9,32	Un.	10
<b>9416/2</b>	3P+T	16	44	09	10,29	Un.	10
<b>9516/2</b>	3P+N+T	16	44	09	12,20	Un.	10
<b>9332/2</b>	2P+T	32	44	09	12,31	Un.	10
<b>9432/2</b>	3P+T	32	44	09	12,99	Un.	10
<b>9532/2</b>	3P+N+T	32	44	09	14,10	Un.	10

**BASES DE EMPOTRAR - IP44**

<b>9210/TC</b>	2P+T(SCH)	16	44	09	5,58	Un.	20
<b>9316/1</b>	2P+T	16	44	09	6,98	Un.	10
<b>9316/1N</b>	2P+T	16	44	09	6,98	Un.	10
<b>9416/1</b>	3P+T	16	44	09	8,28	Un.	10
<b>9516/1</b>	2P+N+T	16	44	09	9,01	Un.	10
<b>9332/1</b>	2P+T	32	44	09	9,66	Un.	10
<b>9432/1</b>	3P+T	32	44	09	9,97	Un.	10
<b>9532/1</b>	3P+N+T	32	44	09	11,18	Un.	10

HF



Ref.	Polos	Amp.	IP	IK	Precio Tab. Uni.	Unid. Med.	Cant. Mín. Prov.
<b>CLAVIJAS - IP67</b>							
679316/4	2P+T	16	67	09	8,21	Un.	10
679416/4	3P+T	16	67	09	9,70	Un.	10
679516/4	3P+N+T	16	67	09	11,36	Un.	10
679332/4	2P+T	32	67	09	12,52	Un.	10
679432/4	3P+T	32	67	09	13,84	Un.	10
679532/4	3P+N+T	32	67	09	15,99	Un.	10
679363/8	2P+T	63	67	09	40,43	Un.	1
679463/8	3P+T	63	67	09	44,10	Un.	1
679563/8	3P+N+T	63	67	09	51,98	Un.	1
<b>PROLONGADORES - IP67</b>							
679316/3	2P+T	16	67	09	9,92	Un.	10
679416/3	3P+T	16	67	09	11,47	Un.	10
679516/3	3P+N+T	16	67	09	13,23	Un.	10
679332/3	2P+T	32	67	09	15,11	Un.	10
679432/3	3P+T	32	67	09	16,43	Un.	10
679532/3	3P+N+T	32	67	09	18,86	Un.	10
679363/7	2P+T	63	67	09	46,20	Un.	1
679463/7	3P+T	63	67	09	50,82	Un.	1
679563/7	3P+N+T	63	67	09	55,44	Un.	1
<b>BASES MURALES - IP67</b>							
679316/2	2P+T	16	67	09	16,58	Un.	10
679416/2	3P+T	16	67	09	16,71	Un.	5
679516/2	3P+N+T	16	67	09	18,42	Un.	5
679332/2	2P+T	32	67	09	19,30	Un.	5
679432/2	3P+T	32	67	09	20,95	Un.	5
679532/2	3P+N+T	32	67	09	23,68	Un.	5
679363/6	2P+T	63	67	09	55,21	Un.	1
679463/6	3P+T	63	67	09	57,52	Un.	1
679563/6	3P+N+T	63	67	09	65,21	Un.	1
<b>BASES DE EMPOTRAR - IP67</b>							
679316/1	2P+T	16	67	09	8,84	Un.	10
679416/1	3P+T	16	67	09	9,65	Un.	10
679516/1	3P+N+T	16	67	09	11,25	Un.	10
679332/1	2P+T	32	67	09	12,13	Un.	10
679432/1	3P+T	32	67	09	13,23	Un.	10
679532/1	3P+N+T	32	67	09	15,60	Un.	8
679363/5	2P+T	63	67	09	36,62	Un.	2
679463/5	3P+T	63	67	09	40,03	Un.	2
679563/5	3P+N+T	63	67	09	45,46	Un.	2

**SERIE FE**  
CLASSIC

HF

**OXLINE****OXLINE**

Ref.	Dimensiones int. (mm)	Nº Ent.	IP	IK	Temp.	Precio Tab. Uni.	Unid. Med.	Cant. Mín. Prov.
<b>CAJAS ESTANCA PARA HILO</b>								
FE7	75x75x37	7	54	07	850°	1,03	Un	10
FE12	85x85x37	12	54	07	850°	1,31	Un	10
FE15	100x100x37	12	54	07	850°	1,80	Un	8
FE25	89x43x37	10	54	07	850°	1,12	Un	10
<b>CAJAS ESTANCAS CON CONOS</b>								
J80-B	83x83x50	7	65	08	750°	1,81	Un	1
J80-B/M2	83x83x50	7	65	08	850°	2,71	Un	1
J80-B/M0	83x83x50	7	65	08	960°	4,51	Un	1
J100-B	102x102x55	7	66	08	750°	2,78	Un	1
J100-B/M2	102x102x55	7	66	08	850°	4,18	Un	1
J100-B/M0	102x102x55	7	66	08	960°	6,95	Un	1
J160-B	102x152x65	10	66	08	750°	5,04	Un	1
J160-B/M2	102x152x65	10	66	08	850°	7,56	Un	1
J160-B/M0	102x152x65	10	66	08	960°	12,60	Un	1
J200-B	152x202x85	10	66	08	750°	9,24	Un	1
J200-B/M2	152x202x85	10	66	08	850°	13,86	Un	1
J200-B/M0	152x202x85	10	66	08	960°	23,10	Un	1
<b>CAJAS ESTANCAS CON PAREDES LISAS</b>								
J80-L	83x83x50	-	65	08	750°	1,81	Un	1
J80-L/M2	83x83x50	-	65	08	850°	2,71	Un	1
J80-L/M0	83x83x50	-	65	08	960°	4,51	Un	1
J100-L	102x102x55	-	66	08	750°	2,78	Un	1
J100-L/M2	102x102x55	-	66	08	850°	4,18	Un	1
J100-L/M0	102x102x55	-	66	08	960°	6,95	Un	1
J160-L	102x152x65	-	66	08	750°	5,04	Un	1
J160-L/M2	102x152x65	-	66	08	850°	7,56	Un	1
J160-L/M0	102x152x65	-	66	08	960°	12,60	Un	1
J200-L	152x202x85	-	66	08	750°	9,24	Un	1
J200-L/M2	152x202x85	-	66	08	850°	13,86	Un	1
J200-L/M0	152x202x85	-	66	08	960°	23,10	Un	1





HF

Ref.	Dimensiones int. (mm)	Nº Ent.	IP	IK	Temp.	Precio Tab. Uni.	Unid. Med.	Cant. Mín. Prov.
<b>CAJAS ESTANCAS CON TAPA ALTA</b>								
J200-BTA	152x202x125	10	66	08	750°	11,97	Un	1
J200-BTA/M2	152x202x125	10	66	08	850°	17,96	Un	1
J200-BTA/M0	152x202x125	10	66	08	960°	29,93	Un	1
J200-BTATR	152x202x125	10	66	08	750°	14,70	Un	1
J200-LTA	152x202x125	-	66	08	750°	11,97	Un	1
J200-LTATR	152x202x125	-	66	08	750°	14,70	Un	1
<b>CAJAS ESTANCAS CON ENTRADAS ROSCADAS 7xM20</b>								
J100-S	102x102x55	7	66	08	750°	3,59	Un	1
J100-S/M2	102x102x55	7	66	08	850°	5,39	Un	1
J100-S/M0	102x102x55	7	66	08	960°	8,98	Un	1

## NUEVAS CAJAS BOXLINE CON ENTRADAS MARCADAS Y MIXTAS





HF

Ref.	Dimensiones int. (mm)	Nº Ent.	IP	IK	Temp.	Precio Tab. Uni.	Unid. Med.	Cant. Mín. Prov.
<b>ENTRADAS MARCADAS CAJAS ESTANCAS CON ENTRADAS MARCADAS (BOXLINE)</b>								
J80-M	83x83x50	7	66	08	750°	1,81	Un	1
J100-M	102x102x55	7	66	08	750°	2,78	Un	1
J160-M	102x152x65	10	66	08	750°	5,04	Un	1
J200-M	152x202x85	10	66	08	750°	9,24	Un	1
<b>KOMBO CAJAS ESTANQUES COM ENTRADAS MIXTAS (BOXLINE)</b>								
J80-MK	83x83x50	7	66	08	750°	1,81	Un	1
J100-MK	102x102x55	7	66	08	750°	2,78	Un	1
<b>PUSH CAJAS BOXLINE CON ENTRADAS RECORTADAS (BOXLINE)</b>								
J80-P	83x83x50	-	65	08	750°	1,81	Un	1
J100-P	102x102x55	-	66	08	750°	2,78	Un	1
J160-P	102x152x65	-	66	08	750°	5,04	Un	1
J200-P	152x202x85	-	66	08	750°	9,24	Un	1



## ACESSÓRIOS

HF



Ref.	Descripción	Precio Tab. Uni.	Unid. Med.	Cant. Mín. Prov.
399/5	Bornera 3 Fases + N + T 500 V	4,41	Un	10
397/5	Bornera	1,75	Un	50
P5-273-5	Soporte p/ 5 conectores 4P rápidos	0,24	Un	20
BM25	Conos Metricos	0,27	Un	50
BM32	Conos Metricos	0,41	Un	50



**SERIE 200**  
 CLASSIC

HF	Ref.	Dimensiones int. (mm)	Nº Ent.	IP	IK	Temp.	Precio Tab. Uni.	Unid. Med.	Cant. Min. Prov.
<b>CAJAS ESTANCAS CON CONOS</b>									
	<b>219B</b>	80x45	4	54	08	750°	1,33	Un	8
	<b>219B/M2</b>	80x45	4	54	07	850°	2,00	Un	10
	<b>219B/M0</b>	80x45	4	54	07	960°	3,34	Un	10
	<b>220B</b>	80x80x50	7	54	08	750°	1,90	Un	10
	<b>220B/M2</b>	80x80x50	7	54	08	850°	2,86	Un	10
	<b>220B/M0</b>	80x80x50	7	54	08	960°	4,75	Un	10
	<b>222B</b>	100x100x55	6	54	09	750°	2,82	Un	1
	<b>222B/M2</b>	100x100x55	6	54	09	850°	4,24	Un	1
	<b>222B/M0</b>	100x100x55	6	54	09	960°	7,06	Un	1
	<b>221B</b>	150x110x70	10	54	09	750°	4,52	Un	1
	<b>221B/M2</b>	150x110x70	10	54	09	850°	6,77	Un	1
	<b>221B/M0</b>	150x110x70	10	54	09	960°	11,28	Un	1
	<b>223B</b>	175x110x65	10	54	09	750°	6,44	Un	1
	<b>223B/M2</b>	175x110x65	10	54	09	850°	9,66	Un	1
	<b>223B/M0</b>	175x110x65	10	54	09	960°	16,10	Un	1
	<b>223BTA</b>	175x110x83	10	54	09	750°	7,30	Un	1
	<b>223BTA/M2</b>	175x110x83	10	54	09	850°	10,95	Un	1
	<b>223BTA/M0</b>	175x110x83	10	54	09	960°	18,25	Un	1
	<b>225B</b>	190x150x70	10	54	09	750°	7,89	Un	1
	<b>225B/M2</b>	190x150x70	10	54	09	850°	11,83	Un	1
	<b>225B/M0</b>	190x150x70	10	54	09	960°	19,70	Un	1
	<b>225BTA</b>	190x150x83	10	54	09	750°	10,32	Un	1
	<b>225BTA/M2</b>	190x150x83	10	54	09	850°	14,78	Un	1
	<b>225BTA/M0</b>	190x150x83	10	54	09	960°	24,64	Un	1
	<b>224B</b>	220x170x120	10	54	09	750°	12,78	Un	1
	<b>224B/M2</b>	220x170x120	10	54	09	850°	19,17	Un	1
	<b>224B/M0</b>	220x170x120	10	54	09	960°	31,94	Un	1
	<b>226B</b>	220x170x105	10	54	09	750°	10,87	Un	1
	<b>226B/M2</b>	220x170x105	10	54	09	850°	14,65	Un	1
	<b>226B/M0</b>	220x170x105	10	54	09	960°	27,17	Un	1

**SERIE 200**  
 CLASSIC



HF	Ref.	Dimensiones int. (mm)	Nº Ent.	IP	IK	Temp.	Precio Tab. Uni.	Unid. Med.	Cant. Mín. Prov.
<b>CAJAS ESTANCAS CON ENTRADAS MARCADAS PG(A) Y METRIC(AM) TIENEN EL MISMO PRECIO)</b>									
	<b>220A</b>	80x80x50	7	54	08	750°	1,47	Un	10
	<b>220A/M2</b>	80x80x50	7	54	08	850°	2,20	Un	10
	<b>220A/M0</b>	80x80x50	7	54	08	960°	3,67	Un	10
	<b>222A</b>	100x100x55	6	65	09	750°	2,92	Un	1
	<b>222A/M2</b>	100x100x55	6	65	09	850°	4,39	Un	1
	<b>222A/M0</b>	100x100x55	6	65	09	960°	7,30	Un	1
	<b>221A</b>	150x110x70	10	65	09	750°	4,75	Un	1
	<b>221A/M2</b>	150x110x70	10	65	09	850°	7,11	Un	1
	<b>221A/M0</b>	150x110x70	10	65	09	960°	11,86	Un	1
	<b>223A</b>	175x110x65	10	65	09	750°	5,92	Un	1
	<b>223A/M2</b>	175x110x65	10	65	09	850°	8,93	Un	1
	<b>223A/M0</b>	175x110x65	10	65	09	960°	14,81	Un	1
	<b>223ATA</b>	175x110x83	10	65	09	750°	6,77	Un	1
	<b>223ATA/M2</b>	175x110x83	10	65	09	850°	10,15	Un	1
	<b>223ATA/M0</b>	175x110x83	10	65	09	960°	16,93	Un	1
	<b>225A</b>	190x150x70	10	65	09	750°	7,89	Un	1
	<b>225A/M2</b>	190x150x70	10	65	09	850°	11,82	Un	1
	<b>225A/M0</b>	190x150x70	10	65	09	960°	19,71	Un	1
	<b>225ATA</b>	190x150x83	10	65	09	750°	9,86	Un	1
	<b>225ATA/M2</b>	190x150x83	10	65	09	850°	14,78	Un	1
	<b>225ATA/M0</b>	190x150x83	10	65	09	960°	24,64	Un	1
	<b>224A</b>	220x170x120	10	65	09	750°	11,67	Un	1
	<b>224A/M2</b>	220x170x120	10	65	09	850°	17,49	Un	1
	<b>224A/M0</b>	220x170x120	10	65	09	960°	29,16	Un	1
	<b>226A</b>	220x170x105	10	65	09	750°	10,02	Un	1
	<b>226A/M2</b>	220x170x105	10	65	09	850°	15,04	Un	1
	<b>226A/M0</b>	220x170x105	10	65	09	960°	25,05	Un	1

**SERIE 200**  
 CLASSIC

HF	Ref.	Dimensiones int. (mm)	Nº Ent.	IP	IK	Temp.	Precio Tab. Uni.	Unid. Med.	Cant. Mín. Prov.
<b>CAJAS ESTANCAS CON PAREDES LISAS</b>									
	<b>220L</b>	80x80x50	-	54	08	750°	1,47	Un	10
	<b>220L/M2</b>	80x80x50	-	54	08	850°	2,20	Un	10
	<b>220L/M0</b>	80x80x50	-	54	08	960°	3,67	Un	10
	<b>222L</b>	100x100x55	-	65	09	750°	2,78	Un	1
	<b>222L/M2</b>	100x100x55	-	65	09	850°	4,18	Un	1
	<b>222L/M0</b>	100x100x55	-	65	09	960°	6,95	Un	1
	<b>221L</b>	150x110x70	-	65	09	750°	4,75	Un	1
	<b>221L/M2</b>	150x110x70	-	65	09	850°	7,11	Un	1
	<b>221L/M0</b>	150x110x70	-	65	09	960°	11,85	Un	1
	<b>223L</b>	175x110x65	-	65	09	750°	5,92	Un	1
	<b>223L/M2</b>	175x110x65	-	65	09	850°	8,94	Un	1
	<b>223L/M0</b>	175x110x65	-	65	09	960°	14,80	Un	1
	<b>223LTA</b>	175x110x83	-	65	09	750°	6,77	Un	1
	<b>223LTA/M2</b>	175x110x83	-	65	09	850°	10,15	Un	1
	<b>223LTA/M0</b>	175x110x83	-	65	09	960°	16,93	Un	1
	<b>225L</b>	190x150x70	-	65	09	750°	7,89	Un	1
	<b>225L/M2</b>	190x150x70	-	65	09	850°	11,82	Un	1
	<b>225L/M0</b>	190x150x70	-	65	09	960°	19,71	Un	1
	<b>225LTA</b>	190x150x83	-	65	09	750°	9,86	Un	1
	<b>225LTA/M2</b>	190x150x83	-	65	09	850°	14,78	Un	1
	<b>225LTA/M0</b>	190x150x83	-	65	09	960°	24,64	Un	1
	<b>224L</b>	220x170x120	-	65	09	750°	11,67	Un	1
	<b>224L/M2</b>	220x170x120	-	65	09	850°	17,49	Un	1
	<b>224L/M0</b>	220x170x120	-	65	09	960°	29,16	Un	1
	<b>226L</b>	220x170x105	-	65	09	750°	10,02	Un	1
	<b>226L/M2</b>	220x170x105	-	65	09	850°	15,04	Un	1
	<b>226L/M0</b>	220x170x105	-	65	09	960°	25,27	Un	1
	<b>MF-242</b>	322x275x185	-	65	09	750°	38,56	Un	1
	<b>MF-244</b>	422x380x185	-	54	09	750°	55,68	Un	1

**SERIE 200**  
 CLASSIC

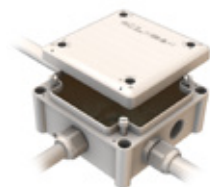
HF	Ref.	Dimensiones int. (mm)	Nº Ent.	IP	IK	Temp.	Precio Tab. Uni.	Unid. Med.	Cant. Mín. Prov.
<b>CAJAS ESTANCAS CON TAPA TRANSPARENTE</b>									
	221ATR	150x110x70	10	65	09	750°	9,198	Un	1
	221BTR	150x110x70	10	54	09	750°	9,198	Un	1
	221LTR	150x110x70	-	65	09	750°	9,198	Un	1
	223ATR	175x110x65	10	65	09	750°	11,42	Un	1
	223BTR	175x110x65	10	54	09	750°	11,42	Un	1
	223LTR	175x110x65	-	65	09	750°	10,90	Un	1
	223ATATR	175x110x83	10	65	09	750°	12,94	Un	1
	223BTATR	175x110x83	10	54	09	750°	11,32	Un	1
	223LTATR	175x110x83	-	65	09	750°	11,32	Un	1
	225ATR	190x150x70	10	65	09	750°	14,65	Un	1
	225BTR	190x150x70	10	54	09	750°	14,65	Un	1
	225LTR	190x150x70	-	65	09	750°	14,65	Un	1
	225ATATR	190x150x83	10	65	09	750°	17,41	Un	1
	225BTATR	190x150x83	10	54	09	750°	18,24	Un	1
	225LTATR	190x150x83	-	65	09	750°	18,24	Un	1
	224ATR	220x170x120	10	65	09	750°	20,62	Un	1
	224BTR	220x170x120	10	54	09	750°	20,62	Un	1
	224LTR	220x170x120	-	65	09	750°	20,62	Un	1
	226ATR	220x170x105	10	65	09	750°	18,39	Un	1
	226BTR	220x170x105	10	54	09	750°	17,56	Un	1
	226LTR	220x170x105	10	54	09	750°	17,56	Un	1
	221AMTR	150x110x70	10	65	09	750°	9,20	Un	1
	223AMTR	175x110x65	10	65	09	750°	11,42	Un	1
	223ATAMTR	175x110x83	10	65	09	750°	12,94	Un	1
	225AMTR	190x150x70	10	65	09	750°	14,65	Un	1
	225ATAMTR	190x150x83	10	65	09	750°	17,41	Un	1
	224AMTR	220x170x120	10	65	09	750°	20,62	Un	1
	226AMTR	220x170x105	10	65	09	750°	18,39	Un	1
	MF-242TR	322x275x185	-	65	09	750°	40,39	Un	1
	MF-242TRP	322x275x185	-	65	09	750°	49,38	Un	1
	MF-244TR	422x380x185	-	54	09	750°	58,33	Un	1
	MF-244TRP	422x380x185	-	54	09	750°	67,31	Un	1

**SERIE 300**  
CLASSIC**SERIE 600**  
CLASSIC**POWER GEL** **POWER RESIN****POWER GEL** **POWER RESIN****GreenBox**

HF

Ref.	Dimensiones int. (mm)	Nº Ent.	IP	IK	Temp.	Precio Tab. Uni.	Unid. Med.	Cant. Mín. Prov.
<b>CAJAS ESTANCAS CON PAREDES LISAS P/ USO DE PRENSAESTOPAS METRICAS</b>								
320	80x80x42	8	-	-	750°	2,34	Un	1
321	80x80x42	-	-	-	750°	2,52	Un	1
322	103x103x45.5	-	-	-	750°	4,75	Un	1
323	106x102x55	-	-	-	750°	7,79	Un	1
<b>CAJAS ESTANCAS CON ENTRADAS MARCADAS P/ USO DE PRENSAESTOPAS METRICAS</b>								
620	86x86x34	8	-	-	750°	4,09	Un	1
621	86x86x34	8	-	-	750°	2,81	Un	1
622	101x101x42	8	-	-	750°	5,10	Un	1
623	126x126x49	12	-	-	750°	9,16	Un	1
624	152x152x58	12	-	-	750°	18,05	Un	1
<b>CAJAS PARA INSTALACIONES ESPECIALES</b>								
<b>CAJAS ESTANQUES PARA INSTALACIÓN ESPECIALES (GEL Y RESINA)</b>								
J100S GKIT	102x102x55	7	68	08	750°	102,90	Un	1
J100S IKIT	102x102x55	7	68	08	750°	86,10	Un	1
J100S IKIT FR	102x102x55	7	68	08	750°	117,60	Un	1
<b>CAJAS ESTANQUES BOXLINE PARA INSTALACIÓN ESPECIALES (GEL Y RESINA)</b>								
J80-BGA	85x85x55	7	68	08	750°	68,25	Un	1
J100-BGA	102x102x55	7	68	08	750°	86,10	Un	1
J160-BGA	102x152x65	10	68	08	750°	96,60	Un	1
J200-BGA	152x202x85	10	68	08	750°	103,95	Un	1
J80-BGAK	85x85x55	7	68	08	750°	91,35	Un	1
J100-BGAK	102x102x55	7	68	08	750°	102,90	Un	1
J160-BGAK	102x152x65	10	68	08	750°	126,00	Un	1
J200-BGAK	152x202x85	10	68	08	750°	148,05	Un	1
<b>CAJAS ESTANCAS PARA INSTALACIÓN EN AMBIENTES / UBICACIÓN VERDES</b>								
J100S-EXT	102x102x56	7	66	08	750°	10,40	Un	1

Incluye: 3 Prensaestopas





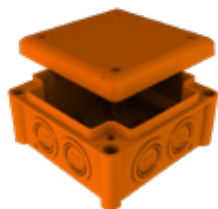

HF	Ref.	Dimensiones int. (mm)	Nº Ent.	IP	IK	Temp.	Precio Tab. Uni.	Unid. Med.	Cant. Mín. Prov.
<b>CAJAS ESTANQUES ANTIFOGO E90</b>									
	J100SF	102x102x55	7	66	08	960°	78,75	Un	1
	J100SF-P10	102x102x55	7	66	08	960°	87,15	Un	1
	J100SF-P16	102x102x55	7	66	08	960°	87,15	Un	1
	J100BF	102x102x55	7	66	08	960°	78,75	Un	1
	J100BF-P10	102x102x55	7	66	08	960°	87,15	Un	1
	J100BF-P16	102x102x55	7	66	08	960°	87,15	Un	1
	J160BF	102x152x65	10	66	08	960°	100,80	Un	1
	J160BF-P16	102x152x65	10	66	08	960°	109,20	Un	1
	J200BF	152x202x85	10	66	08	960°	144,90	Un	1
	J200BF-P33	152x202x85	10	66	08	960°	Consultar Precio	Un	1
	J200BF-P55	152x202x85	10	66	08	960°	Consultar Precio	Un	1
<b>CAJAS ESTANQUES ANTIFOGO E90 CON ENTRADAS MARCADAS</b>									
	J100MF	102x102x55	7	66	08	960°	87,15	Un	1
	J100MF-P10	102x102x55	7	66	08	960°	87,15	Un	1
	J100MF-P16	102x102x55	7	66	08	960°	87,15	Un	1
	J160MF	102x152x65	10	66	08	960°	100,80	Un	1
	J160MF-P16	102x152x65	10	66	08	960°	109,20	Un	1
	J200MF	152x202x85	10	66	08	960°	144,90	Un	1
	J200MF-P33	152x202x85	10	66	08	960°	Consultar Precio	Un	1
	J200MF-P55	152x202x85	10	66	08	960°	Consultar Precio	Un	1
<b>ACCESORIOS PARA CAJAS ESTANQUES ANTIFOGO E90</b>									
	J100SF-MCP	-	-	-	-	-	31,50	Un	1
	M16/V0	-	-	-	-	-	1,24	Un	50
	M20/V0	-	-	-	-	-	1,40	Un	50
	M25/V0	-	-	-	-	-	2,31	Un	20
	M32/V0	-	-	-	-	-	3,80	Un	20
	M40/V0	-	-	-	-	-	7,40	Un	10

HF

Ref.	Precio Tab. Uni.	Unid. Med.	Cant. Mín. Prov.
<b>PRENSAESTOPAS PG</b>			
PG7	0.483	Un	50
PG9	0.515	Un	50
PG11	0.557	Un	50
PG13.5	0.599	Un	50
PG16	0.683	Un	50
PG21	1.334	Un	20
PG29	2.342	Un	20
PG36	3.423	Un	10
PG48	5.513	Un	5
<b>PRENSAESTOPAS METRICAS</b>			
M12	0.483	Un	50
M16	0.525	Un	50
M20	0.567	Un	50
M25	0.872	Un	20
M32	1.691	Un	20
M40	2.993	Un	10
M50	5.691	Un	5
M63	7.287	Un	5
<b>PRENSAESTOPAS HÍBRIDO (PG16/M20)</b>			
313	0.662	Un	50
<b>TUERCAS PG</b>			
PG7-P	0.168	Un	50
PG9-P	0.168	Un	50
PG11-P	0.168	Un	50
PG13.5-P	0.179	Un	50
PG16-P	0.210	Un	50
PG21-P	0.326	Un	50
PG29-P	0.578	Un	50
PG36-P	1.428	Un	50
PG48-P	2.289	Un	50
<b>PORCA MÉTRICA</b>			
M12-P	0.083	Un	50
M16-P	0.086	Un	50
M20-P	0.095	Un	50
M25-P	0.105	Un	50
M32-P	0.231	Un	50
M40-P	0.326	Un	50
M50-P	0.557	Un	50
M63-P	0.798	Un	50
<b>TAPAS PG</b>			
PG7-T	0.147	Un	50
PG9-T	0.147	Un	50

HF

Ref.	Precio Tab. Uni.	Unid. Med.	Cant. Mín. Prov.
PG11-T	0,147	Un	50
PG13.5-T	0,158	Un	50
PG16-T	0,179	Un	50
PG21-T	0,231	Un	20
PG29-T	0,504	Un	20
PG36-T	1,082	Un	10
PG48-T	1,365	Un	10
<b>CONOS PG</b>			
PG16-B	0,210	Un	50
PG21-B	0,294	Un	50
PG29-B	0,777	Un	50
<b>RACORES TUBO/CAJA CON TUERCA</b>			
R16-HF	0,50	Un	100
R16-MHF	0,50	Un	100
R20-HF	0,55	Un	50
R20-MHF	0,55	Un	50
R1620-HF	0,63	Un	50
R25-HF	1,64	Un	25
R25-MHF	1,64	Un	25
R32-HF	2,42	Un	25
R40-HF	3,68	Un	25
R50-HF	5,15	Un	10
R63-HF	6,12	Un	5
<b>CONECTORES RAPIDOS</b>			
273-102	0,21	Un	100
N273-103	0,23	Un	100
N273-104	0,28	Un	100
N273-105	0,33	Un	100
<b>SOLFLEX -CONECTORES RAPIDOS</b>			
222-3	0,47	Un	50
222-5	0,74	Un	25
<b>PLACAS DE BORNES / CAPUCHON</b>			
397/3	1.62	Un	20
397/4	1,94	Un	20
397/5	1,75	Un	50
397/3A	1,37	Un	50
398/3	1,23	Un	50
398/5	1,65	Un	50
<b>TORIX</b>			
362	0,173	Un	100
<b>CAJAS DE DERIVACIÓN C/ BORNERAS</b>			
325/2	3,15	Un	10
325/3	3,63	Un	10
325/4	4,10	Un	10













HF

Ref.	Descripción	Dimensiones (mm)	Precio Tab. Uni.	Unid. Med.	Cant. Min. Prov.
<b>CAJAS PARA PAREDES HUECAS</b>					
403	Caja punto Luz c/ tapa	44x38	1,50	Un	10
404	Caja para mecanismos enlazable	65x50	0,87	Un	10
405	Caja derivación c/ tapa	110x110x40	2,20	Un	8
406	Caja para mecanismos enlazable	65x60	0,96	Un	10
407	Caja para mecanismos enlazable	65x40	0,81	Un	10
408	Caja double enlazable	65x142x50	2,31	Un	5
424	Caja para mecanismos enlazable	68x45	0,87	Un	10
426	Caja para mecanismos enlazable	68x60	0,96	Un	10
428	Caja dupla para mecan. enlazable	68x142x45	2,31	Un	5
429	Caja tripla para mecan. enlazable	68x213x45	3,47	Un	5
409	Accesorio de enlace	-	0,11	Un	50
409-U	Tunel paso de cables	-	0,11	Un	50
<b>CAJAS PARA LADRILHO</b>					
319N	Caja de mecanismos	60x42	0,37	Un	10
317N	Caja de mecanismos	60x65	0,49	Un	10
319-T	Tapa para caja de mecanismos	80	0,39	Un	50
316	Caja de mecanismos	75x75x42	0,34	Un	20
318	Caja de mecanismos	75x75x60	0,44	Un	10
430	Caja de mecanismos (20 entradas)	70x70x42	0,76	Un	10
431	Caja de mecanismos (20 entradas)	75x75x60	0,85	Un	10
315A-ST	Caja de derivación enlazable s/tapa	100x100x45	0,66	Un	10
315A	Caja de derivación enlazable c/tapa	125x125x45	0,83	Un	10
315A/2	Caja de derivación doble c/tapa	225x125x45	1,68	Un	5
315A/3	Caja de derivación triple c/tapa	325x125x45	2,57	Un	5
324A	Tapa para caja simple 315A-ST	125x125	0,18	Un	20
325A	Tapa para caja doble 315A-ST	225x125	0,39	Un	20
326A	Tapa para caja triple 315A-ST	325x125	0,59	Un	10
315-ST	Caja de derivación enlazable s/tapa	80x80x40	0,69	Un	10
315	Caja de derivación enlazable c/tapa	90x90x40	0,88	Un	10
315/2	Caja de derivación doble c/tapa	180x90x40	1,94	Un	4
315/3	Caja de derivación triple c/tapa	270x90x40	2,91	Un	3
324	Tapa para caja simple 315-ST	90x90	0,19	Un	100

HF

Ref.	Descripción	Dimensiones (mm)	Precio Tab. Uni.	Unid. Med.	Cant. Min. Prov.
<b>325</b>	Tapa para caja doble 315-ST	180x90	0,56	Un	50
<b>326</b>	Tapa para caja triple 315-ST	270x90	0,83	Un	50
<b>400-ST</b>	Caja de derivación s/tapa	83x40	0,84	Un	10
<b>400</b>	Caja de derivación c/ tapa	83x40	1,22	Un	10
<b>401</b>	Caja de derivación c/tapa redonda	83x40	1,16	Un	10
<b>400-T</b>	Tapa redonda para ref: 400-ST	90	0,38	Un	50
<b>401-T</b>	Tapa cuadrada para ref: 400-ST	90x90	0,38	Un	50
<b>402-ST</b>	Caja punto de luz sin tapa	40x34	0,47	Un	10
<b>402-T</b>	Tapa para Caja punto de luz	42	0,30	Un	10
<b>501001</b>	Tapa universal para ref: 404/406/407/424/426	60	0,17	Un	50
<b>I1</b>	Cajas empotradas para Telecomunicaciones	62x50	0,64	Un	10
<b>I2</b>	Cajas empotradas para Telecomunicaciones	90x90x50	1,68	Un	10
<b>I3</b>	Cajas empotradas para Telecomunicaciones	180x90x50	2,72	Un	5
<b>CAJAS PARA HORMIGON</b>					
<b>811</b>	Cajas para mecanismos	-	1,07	Un	10
<b>812</b>	Tapa "Diafragma"	-	0,59	Un	10
<b>813</b>	Tapa Submergible	-	1,10	Un	10
<b>814</b>	Manga para hacer caja de pasaje	-	1,10	Un	10
<b>841</b>	Caja de derivación	-	1,95	Un	10
<b>842</b>	Tapa estancia	-	0,86	Un	10
<b>843</b>	Tapa de acabado	-	1,34	Un	10
<b>801</b>	Caja techo tipo "Pagode"	-	1,30	Un	10
<b>802</b>	Tapa estancia	-	0,64	Un	10
<b>803</b>	Tapa de acabado	-	0,74	Un	10
<b>804</b>	Suspension para caja	-	2,29	Un	10
<b>831</b>	Caja de reserva	-	1,10	Un	10
<b>832</b>	Tapa estancia	-	0,86	Un	10
<b>821</b>	Caja Punto de luz	-	1,10	Un	10
<b>822</b>	Tapa estancia	-	0,71	Un	10
<b>823</b>	Tapa de acabado	-	0,86	Un	10

HF	Ref.	Descripción	Dimensiones (mm)	Precio Tab. Uni.	Unid. Med.	Cant. Min. Prov.
	<b>CUADROS DE DISTRIBUCIÓN DE EMPOTRAR</b>					
	Cuadros hasta 26 Módulos y 110 mm de funda					
	<b>A200/4</b>	Cuadros de dist. de empotrar hasta 26 módulos	504x360x126	61,95	Un	1
	<b>A200/2</b>	Cuadros de dist. de empotrar hasta 26 módulos	504x360x126	48,30	Un	1
	<b>A200</b>	Cuadros de dist. de empotrar hasta 26 módulos	504x360x126	37,80	Un	1
	<b>V200</b>	Versión de pre-instalación (caja vacía)	-	10,50	Un	1
	<b>K200/4</b>	Versión de pre-instalación - Incluye 4 Bornas	-	75,60	Un	1
	<b>K200/2</b>	Versión de pre-instalación - Incluye 2 Bornas	-	56,70	Un	1
	<b>K200</b>	Versión de pre-instalación - Kit de acabado	-	35,70	Un	1
	Cuadros hasta 24 Módulos y 75 mm de funda					
	<b>A300/4</b>	Cuadros de dist. de empotrar hasta 24 módulos	504x360x94	61,95	Un	1
	<b>A300/2</b>	Cuadros de dist. de empotrar hasta 24 módulos	504x360x94	48,30	Un	1
	<b>A300</b>	Cuadros de dist. de empotrar hasta 24 módulos	504x360x94	37,80	Un	1
	<b>V300</b>	Versión de pre-instalación (caja vacía)	-	10,50	Un	1
	<b>K300/4</b>	Versión de pre-instalación - Incluye 4 Bornas	-	75,60	Un	1
	<b>K300/2</b>	Versión de pre-instalación - Incluye 2 Bornas	-	56,70	Un	1
	<b>K300</b>	Versión de pre-instalación - Kit de acabado	-	35,70	Un	1
	Cuadros hasta 40 Módulos y 75 mm de funda					
	<b>A400/4</b>	Cuadros de dist. de empotrar hasta 40 módulos	509x480x94	72,45	Un	1
	<b>A400/2</b>	Cuadros de dist. de empotrar hasta 40 módulos	509x480x94	63,00	Un	1
	<b>A400</b>	Cuadros de dist. de empotrar hasta 40 módulos	509x480x94	52,50	Un	1
	<b>V400</b>	Versión de pre-instalación (caja vacía)	-	11,55	Un	1
	<b>K400/4</b>	Versión de pre-instalación - Incluye 4 Bornas	-	78,75	Un	1
	<b>K400/2</b>	Versión de pre-instalación - Incluye 2 Bornas	-	58,80	Un	1
	<b>K400</b>	Versión de pre-instalación - Kit de acabado	-	45,15	Un	1
	<b>CAJAS PARA ICP Y DISTRIBUITION ESTANCAS Y CAJAS ICT</b>					
	<b>MF-242</b>	Caja de dist. con puerta, Cerradura y Clave	330x280x175	38,56	Un	1
	<b>MF-244</b>	Caja de dist. con puerta, Cerradura y Clave	430x390x175	55,68	Un	1
	<b>MF-242TR</b>	Caja de dist. con puerta tranp. Cerradura y Clave	330x280x175	40,39	Un	1
	<b>MF-244TR</b>	Caja de dist. con puerta tranp. Cerradura y Clave	330x280x175	58,33	Un	1
	<b>MF-242TRP</b>	Caja de dist. con puerta policarbonato, Cerradura y Clave	430x390x175	49,38	Un	1
	<b>MF-244TRP</b>	Caja de dist. con puerta policarbonato, Cerradura y Clave	430x390x175	67,31	Un	1
	<b>CAJAS COMPLETAS PARA ICP Y DISTRIBUITION ESTANCAS Y CAJAS ICT</b>					
	<b>242TRC</b>	Caja de dist. completa estanco hasta 24 módulos.	330x280x175	71,40	Un	1
	<b>244TRC</b>	Caja de dist. completa estanco hasta 54 módulos.	430x390x175	96,12	Un	1
	<b>ACCESORIOS PARA CAJAS PARA ICP Y DISTRIBUITION ESTANCAS</b>					
	<b>242 CL</b>	Placa termoplástica lisa	317x267x11	6,02	Un	10
	<b>244 CL</b>	Placa termoplástica lisa	413x373x11	9,69	Un	10
	<b>271 MF</b>	Tapa Cubre Módulos	-	0,70	Un	10
	<b>242 QD</b>	Cuadro de Distribución p/ ap.modulares	322x272x11	3,39	Un	1
	<b>244 QD</b>	Cuadro de Distribución p/ ap.modulares	418x378x11	5,58	Un	1
	<b>273 MF</b>	Tapa cubre módulos uni. para todo tipo de cuadros	200x52x8	0,62	Un	1
	<b>270 MF</b>	Soporte de Fijación para Cuadro de Distribución (par)	-	1,13	Un	10
	<b>208 MF</b>	Rail DIN EN 50022	35x7,5x208	1,92	Un	1
	<b>239 MF</b>	Rail DIN EN 50022	35x7,5x239	2,04	Un	1
	<b>314 MF</b>	Rail DIN EN 50022	35x7,5x314	2,17	Un	1
	<b>344 MF</b>	Rail DIN EN 50022	35x7,5x344	2,29	Un	1







HF	Ref.	Descripción	Dimensiones (mm)	Precio Tab. Uni.	Unid. Med.	Cant. Min. Prov.
	<b>290 MF</b>	Cerradura en Nylon y c/ Clave	-	2,07	Un	10
	<b>290 S</b>	Cerradura triangular para sellar	-	1,41	Un	10
	<b>291 MF</b>	Clave triangular normalizada	-	0,50	Un	20
	<b>292 MF</b>	Cerradura de metal de seg. c/Clave	-	21,35	Un	10
	<b>293 MF</b>	Ventilador (par)	-	2,42	Un	10

CUADROS PARA ICP Y DISTRIBUITÓN ESTANCOS Y CAJAS ICT

	<b>250-5B</b>	Cuadros de dist. estancos con conos	150x110x70	19,28	Un	1
	<b>250-9B</b>	Cuadros de dist. estancos con conos	190x150x70	30,62	Un	1
	<b>250-11B</b>	Cuadros de dist. estancos con conos	220x170x120	36,29	Un	1
	<b>250-5L</b>	Cuadros de dist. estancos con paredes lisas	150x110x70	19,28	Un	1
	<b>250-9L</b>	Cuadros de dist. estancos con paredes lisas	190x150x70	30,62	Un	1
	<b>250-11L</b>	Cuadros de dist. estancos con paredes lisas	220x170x120	36,29	Un	1
	<b>250-5A</b>	Cuadros de dist. estancos con entradas marcadas	150x110x70	19,28	Un	1
	<b>250-9A</b>	Cuadros de dist. estancos con entradas marcadas	190x150x70	30,62	Un	1
	<b>250-11A</b>	Cuadros de dist. estancos con entradas marcadas	220x170x120	36,29	Un	1
	<b>250-5AM</b>	Cuadros de dist. estancos con entradas marcadas	150x110x70	19,28	Un	1
	<b>250-9AM</b>	Cuadros de dist. estancos con entradas marcadas	190x150x70	30,62	Un	1
	<b>250-11AM</b>	Cuadros de dist. estancos con entradas marcadas	220x170x120	36,29	Un	1

REPARTIDORES MODULARES PROTEGIDOS

	<b>125112 BD</b>	Bipolares con Placa aislante en cada borna y Tapa de protección transparente, auto-extinguible	109x47x45	24,74	Un	1
	<b>125152 BD</b>	Bipolares con Placa aislante en cada borna y Tapa de protección transparente, auto-extinguible	137x47x45	25,60	Un	1
	<b>10074 BD</b>	Tetrapolares con Placa aislante en cada borna y Tapa de protección transparente, auto-extinguible	75x98x45	26,44	Un	1
	<b>125114 BD</b>	Tetrapolares con Placa aislante en cada borna y Tapa de protección transparente, auto-extinguible	112x98x45	41,48	Un	1
	<b>125154 BD</b>	Tetrapolares con Placa aislante en cada borna y Tapa de protección transparente, auto-extinguible	141x98x45	46,33	Un	1
	<b>160134 BD</b>	Tetrapolares con Placa aislante en cada borna y Tapa de protección transparente, auto-extinguible	188x136x70	79,44	Un	1

LIGADORES SUPLEMENTARES

	<b>651S15A</b>	Borna de tierra (verde)	107x13x26	7,04	Un	10
	<b>651S15V</b>	Borna de neutro (azul)	107x13x26	7,04	Un	10

HF

Ref.	Descripción	Dimensiones (mm)	Precio Tab. Uni.	Unid. Med.	Cant. Mín. Prov.
<b>CAJAS CONTADOR MONOFASICO</b>					
<b>PJN 242</b>	Contador monofasico	330x280x175	47,19	Un	1
<b>PJN 244</b>	Contador monofasico ou trifasico	430x390x175	65,12	Un	1
<b>MC 242</b>	Placa universal para contadores	313x260x20	6,48	Un	1
<b>CAJAS DE COLUMNA</b>					
<b>262-CAD/CBQ</b>	Cajas de deriv. columna empotrar	395x300x116	47,41	Un	1
<b>264-CAQ/CBQ</b>	Cajas de deriv. columna empotrar	550x415x116	66,15	Un	1
<b>BORNES E PLACAS DE BORNES</b>					
<b>265</b>	Placa de bornas (269) + 5 bornas (266)	28x35x28	67,16	Un	2
<b>266</b>	Borna Latón Macizo	28x35x28	11,37	Un	10
<b>267</b>	Borna Latón Macizo	81x81x80	77,70	Un	1
<b>269</b>	Recibe hasta 5 bornas (REF.266)	170x70x52	8,40	Un	1

## ILUMINACIÓN

HF

Ref.	Descripción	Precio Tab. Uni.	Unid. Med.	Cant. Mín. Prov.
<b>APLIQUES ESTANCOS</b>				
<b>460</b>	Apliques estancos	10,82	Un	1
<b>470</b>	Apliques estancos	17,35	Un	1
<b>471</b>	Apliques estancos	10,82	Un	1
<b>SOPORTES PARA TUBOS DE FLUORESCENCIA</b>				
<b>349</b>	Portalamparas simple con bornas	1,05	Un	50
<b>350</b>	Portalamparas con portacebador con bornas	1,71	Un	25
<b>478</b>	Portalamparas simples (conexión rápida)	0,99	Un	50
<b>479</b>	Portalamparas con portacebador (conex. rápida)	1,41	Un	25
<b>392</b>	Portalamparas de topo (conexión rápida)	0,82	Un	100
<b>353</b>	Portacebador (conexión rápida)	0,56	Un	50
<b>PORTALAMPARAS PARA LAMPARAS INCANDESCENTES</b>				
<b>358</b>	Casquillo metal	1,23	Un	50
<b>359</b>	Casquillo metal	1,73	Un	50
<b>360</b>	Casquillo Plastico	1,31	Un	50

NUEVO

# SUPER T

## Abrazadera Premium JSL

Esta nueva serie presenta un diseño moderno, centrado en aumentar la funcionalidad y la versatilidad de la instalación, sin olvidar la compatibilidad con las anteriores series de abrazaderas y accesorios similares.

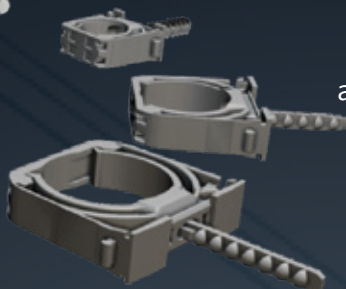

Micro ajuste con 10 pasos  
10mm de amplitud total



**Enlazable**

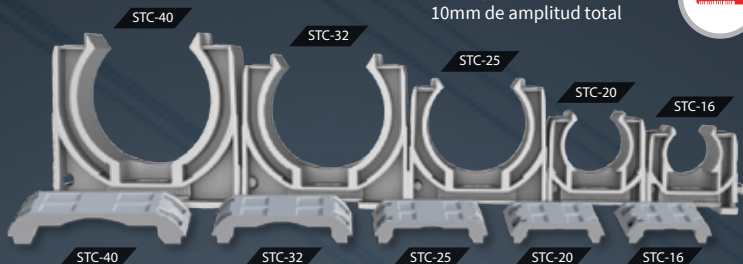

**Compatibilidad:** Compatible con otros modelos de abrazaderas de las series anteriores de JSL

La cubierta de cierre de las abrazaderas asegura que no se retiren cables o tuberías cuando se accede a la instalación con la mano.

NUEVO

## ACCESORIOS COMPATIBLES

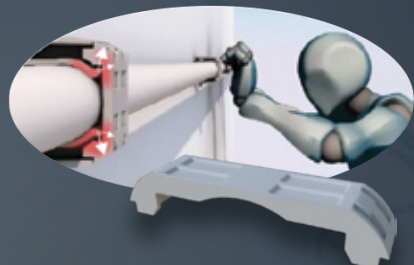

La tentativa de remoción de los tubos o cables, hace que los laterales de la abrazadera ejercen una presión sobre la cubierta, bloqueándola e impidiendo su retirada y manteniendo la instalación firmemente fijada.

HF

Ref.

Precio Tab.  
Unid.Unid.  
Med.Qt. Mín.  
Forn.

## ABRAZADERAS AGRUPABLES SUPER-T

	<b>ST-16</b>	Abrazadera SUPER-T para el Tubo VD 16mm	0.152	Un	100
	<b>ST-20</b>	Abrazadera SUPER-T para el Tubo VD 20mm	0.194	Un	100
	<b>ST-25</b>	Abrazadera SUPER-T para el Tubo VD 25mm	0.227	Un	100
	<b>ST-32</b>	Abrazadera SUPER-T para el Tubo VD 32mm	0.249	Un	100
	<b>ST-40</b>	Abrazadera SUPER-T para el Tubo VD 40mm	0.336	Un	50
	<b>STC-16</b>	Cubierta para abrazadera SUPER-T ST-16 VD 16mm	0.091	Un	100
	<b>STC-20</b>	Cubierta para abrazadera SUPER-T ST-20 VD 20mm	0.105	Un	100
	<b>STC-25</b>	Cubierta para abrazadera SUPER-T ST-25 VD 25mm	0.150	Un	100
	<b>STC-32</b>	Cubierta para abrazadera SUPER-T ST-32 VD 32mm	0.209	Un	100
	<b>STC-40</b>	Cubierta para abrazadera SUPER-T ST-40 VD 40mm	0.238	Un	50
	<b>PST-5</b>	Taco rápido simple de 27mm 6ø mm para fijación con abrazadera SUPER-T y otras	0.062	Un	100
	<b>PST-7</b>	Taco rápido simple de 42mm 6ø mm para fijación con abrazadera SUPER-T y otras	0.068	Un	100
	<b>PSTB-4</b>	Tacos rápidos base ajustable 27mm 6ø mm para fijación con abrazadera SUPER-T y abrazaderas para alta temperatura	0.092	Un	100
	<b>PSTB-7</b>	Tacos rápidos base ajustable 42mm 6ø mm para fijación con abrazadera SUPER-T y abrazaderas para alta temperatura	0.105	Un	100
	<b>ST-CLIP</b>	Soporte Clip (de pinza) con base ajustable para fijar SUPER-T y abrazaderas para alta temperatura	0.096	Un	100
	<b>ST-BASE</b>	Base de cuello con base ajustable para fijar la pinza SUPER-T y abrazaderas para alta temperatura	0.093	Un	100

HF

Ref.	Precio Tab. Uni.	Unid. Med.	Cant. Mín. Prov.
<b>ABRAZADERAS DE CIERRE AGRUPABLES CON TACO CON TACO M6 RAPIDO</b>			
<b>2035/D</b>	0,287	Un	50
<b>2036/D</b>	0,342	Un	50
<b>2037/D</b>	0,408	Un	50
<b>ABRAZADERAS DE CIERRE ENLAZABLES</b>			
<b>2035</b>	0,154	Un	50
<b>2036</b>	0,237	Un	50
<b>2037</b>	0,303	Un	50
<b>2038</b>	0,393	Un	50
<b>2039</b>	0,722	Un	25
<b>ABRAZADERAS PARA CABLES Y TUBO ENLAZABLES SERIE 200 CON TACO M6 RAPIDO</b>			
<b>204/D</b>	0,294	Un	100
<b>208/D</b>	0,375	Un	100
<b>211/D</b>	0,263	Un	100
<b>ABRAZADERAS PARA CABLES Y TUBO ENLAZABLES SERIE 200</b>			
<b>201 (VD12)</b>	0,149	Un	100
<b>202</b>	0,160	Un	100
<b>211 (VD16)</b>	0,152	Un	100
<b>203</b>	0,198	Un	100
<b>204 (VD20)</b>	0,194	Un	100
<b>205</b>	0,226	Un	100
<b>208 (VD25)</b>	0,227	Un	100
<b>206</b>	0,298	Un	50
<b>209 (VD32)</b>	0,249	Un	50
<b>207</b>	0,342	Un	50
<b>210 (VD40)</b>	0,336	Un	25
<b>ABRAZADERAS PARA CABLES Y TUBO ENLAZABLES SERIE 100</b>			
<b>100 (VD12)</b>	0,174	Un	100
<b>101</b>	0,188	Un	100
<b>102 (VD16)</b>	0,202	Un	100
<b>103</b>	0,250	Un	100

HF

Ref.	Precio Tab. Uni.	Unid. Med.	Cant. Mín. Prov.
<b>104 (VD20)</b>	0,235	Un	100
<b>105</b>	0,309	Un	100
<b>106</b>	0,370	Un	100
<b>107 (VD40)</b>	0,538	Un	50
<b>108 (VD50)</b>	0,669	Un	25
<b>110 (VD63)</b>	0,928	Un	25
<b>PUERTA CABLES DE FIJACIÓN VERTICAL O LATERAL</b>			
<b>710-15</b>	0,526	Un	100
<b>710-30</b>	0,842	Un	50
<b>ABRAZADERAS CON APERTURA MECÁNICA (TORNILLO METALICO)</b>			
<b>305</b>	0,226	Un	100
<b>306</b>	0,320	Un	100
<b>307</b>	0,592	Un	50
<b>308</b>	0,953	Un	25
<b>309</b>	2,371	Un	10
<b>305/2</b>	0,437	Un	100
<b>305/3</b>	0,706	Un	50
<b>306/2</b>	0,639	Un	50
<b>306/3</b>	1,142	Un	25
<b>ABRAZADERAS CON APERTURA MECÁNICA (TORNILLO NYLON)</b>			
<b>905</b>	0,237	Un	100
<b>906</b>	0,336	Un	100
<b>907</b>	0,543	Un	50
<b>908</b>	0,953	Un	25
<b>905/2</b>	0,314	Un	100
<b>906/2</b>	0,507	Un	50
<b>ABRAZADERAS PARA CABLES TIPO CLIP</b>			
<b>511</b>	0,132	Un	100
<b>512</b>	0,149	Un	100
<b>513</b>	0,176	Un	100
<b>514</b>	0,183	Un	100
<b>515</b>	0,221	Un	100

HF

Ref.	Precio Tab. Uni.	Unid. Med.	Cant. Mín. Prov.
516	0,359	Un	60
517	0,391	Un	50
518	0,423	Un	50
519	0,473	Un	50
511/2	0,257	Un	100
512/2	0,288	Un	50
513/2	0,347	Un	50
514/2	0,362	Un	50
515/2	0,463	Un	50
516/2	0,549	Un	25
517/2	0,649	Un	25
<b>ABRAZADERAS PARA MONTAGE EM GUIA (MONTAGE EM GUIA C11)</b>			
2047	0,226	Un	100
2048	0,303	Un	100
2049	0,249	Un	100
2050	0,278	Un	100
2051	0,419	Un	100
2051-U	0,440	Un	100
<b>GUIA DE ACERO GALVANIZADO (PERFIL DIN C11)</b>			
2060-PF	8,647	Un	24
<b>GRAPILLA CON CLAVO DE ACERO TEMPLADO PARA HORMIGÓN (KS006)</b>			
3003/15	0,038	Un	100
3003/20	0,038	Un	100
3003A/15	0,048	Un	100
3003A/20	0,048	Un	100
3004/18	0,038	Un	100
3004/25	0,038	Un	100
3005/18	0,041	Un	100
3005/25	0,041	Un	100
3006/18	0,041	Un	100

HF

Ref.	Precio Tab. Uni.	Unid. Med.	Cant. Mín. Prov.
3006/25	0,041	Un	100
3006/35	0,041	Un	100
3007/18	0,045	Un	100
3007/25	0,045	Un	100
3007/35	0,045	Un	100
3008/20	0,045	Un	100
3008/25	0,045	Un	100
3008/35	0,045	Un	100
3008/45	0,045	Un	100
3009/20	0,048	Un	100
3009/25	0,048	Un	100
3009/35	0,048	Un	100
3009/45	0,048	Un	100
3010/25	0,050	Un	100
3010/35	0,050	Un	100
3010/45	0,050	Un	100
3011/25	0,057	Un	100
3011/35	0,057	Un	100
3011/45	0,057	Un	100
3012/25	0,080	Un	100
3012/35	0,080	Un	100
3012/45	0,080	Un	100
3014/30	0,116	Un	50
3014/40	0,116	Un	50
3014/50	0,116	Un	100
3016/30	0,127	Un	25
3016/40	0,127	Un	25
3016/50	0,127	Un	25
3018/40	0,139	Un	25
3018/50	0,139	Un	25
3020/40	0,169	Un	25
3020/50	0,169	Un	25

HF

Ref.	Precio Tab. Uni.	Unid. Med.	Cant. Mín. Prov.
<b>GRAPILLAS C/ CLAVO DE ACERO TEMPLADO PARA HORMIGÓN (KS006) TIPO UNIVERSAL</b>			
<b>700/2.5-4</b>	0,038	Un	100
<b>700/5-7</b>	0,049	Un	100
<b>700/8-10</b>	0,056	Un	100
<b>700/11-15</b>	0,084	Un	100
<b>700/16-19</b>	0,133	Un	50
<b>700/23-29</b>	0,260	Un	50
<b>GRAPILLAS C/ CLAVO DE ACERO TEMPLADO PARA HORMIGÓN (KS006) TIPO UNIVERSAL</b>			
<b>700S</b>	0,158	Un	50
<b>700D</b>	0,189	Un	50
<b>GRAPILLA C/ CLAVO DE ACERO TEMPLADO (KS006) PARA CABLE COAXIAL</b>			
<b>701/TV</b>	0,149	Un	100
<b>GRAPILLA C/CLAVO ACERO TEMPLADO (KS006) - CABO PARALELO</b>			
<b>702/0</b>	0,040	Un	200
<b>702/1</b>	0,044	Un	200
<b>702/2</b>	0,049	Un	100
<b>702/3</b>	0,056	Un	100
<b>GRAPILLA ENLAZABLE TIPO "UNIVERSAL" PARA ALTA TEMPERATURA</b>			
<b>031</b>	0,247	Un	50
<b>032</b>	0,362	Un	50
<b>FIJA CABLES PARA CABLES PARALELOS</b>			
<b>704-40</b>	0,091	Un	100
<b>704-50</b>	0,092	Un	100
<b>704-60</b>	0,096	Un	100
<b>704-70</b>	0,110	Un	100
<b>ABRAZADERA PARA ALTA TEMPERATURA</b>			
<b>461</b>	0,029	Un	100
<b>462</b>	0,036	Un	100
<b>463</b>	0,042	Un	100
<b>464</b>	0,055	Un	100
<b>465</b>	0,063	Un	100

HF

Ref.	Precio Tab. Uni.	Unid. Med.	Cant. Mín. Prov.
<b>466</b>	0,074	Un	100
<b>467</b>	0,099	Un	100
<b>468</b>	0,216	Un	100
<b>469</b>	0,309	Un	100
<b>470</b>	0,060	Un	100
<b>ACCESORIOS PARA BRIDAS</b>			
<b>111</b>	0,066	Un	100
<b>112</b>	0,086	Un	100
<b>113</b>	0,245	Un	100
<b>113-A</b>	0,097	Un	100
<b>ACCESORIOS PARA FIJACIÓN</b>			
<b>BM6</b>	0,118	Un	100
<b>216</b>	0,072	Un	100
<b>215</b>	0,185	Un	100
<b>TACOS</b>			
<b>505</b>	0,023	Un	1
<b>506</b>	0,023	Un	500
<b>507</b>	0,027	Un	500
<b>508</b>	0,034	Un	250
<b>510</b>	0,044	Un	100
<b>CLAVOS DE ACERO TEMPLADO PARA HORMIGÓN, ZINCADOS</b>			
<b>362/16</b>	0,020	Un	1
<b>362/23</b>	0,020	Un	1
<b>362/30</b>	0,027	Un	1
<b>362/40</b>	0,034	Un	1
<b>362/50</b>	0,048	Un	1
<b>PERNOS DE ACERO ZINCADO BLANCO M6</b>			
<b>903/18</b>	0,139	Un	100
<b>903/25</b>	0,151	Un	100
<b>903/30</b>	0,162	Un	100
<b>903/40</b>	0,174	Un	100
<b>903/55</b>	0,255	Un	100
<b>903/70</b>	0,308	Un	100

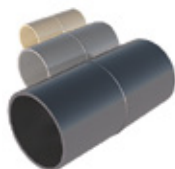
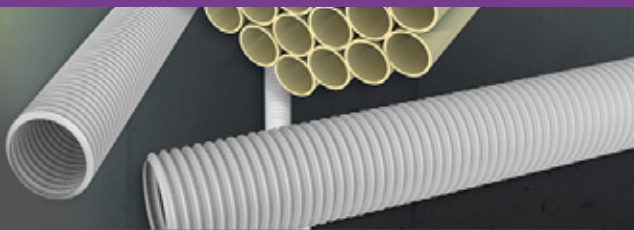
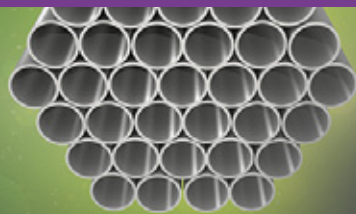

Ref.	Precio Tab. Uni.	Unid. Med.	Cant. Min. Prov.
<b>TUBO VD METRICO RIGIDO</b>			
<b>VD12</b>	0,61	Mt.	111
<b>VD16</b>	0,73	Mt.	111
<b>VD20</b>	1,13	Mt.	111
<b>VD16F</b>	1,01	Mt.	111
<b>VD20F</b>	1,45	Mt.	111
<b>VD25</b>	1,73	Mt.	57
<b>VD32</b>	2,54	Mt.	57
<b>VD40</b>	3,25	Mt.	30
<b>VD50</b>	5,32	Mt.	15
<b>VD63</b>	6,89	Mt.	15
<b>VD75</b>	11,74	Mt.	15
<b>VD90</b>	16,33	Mt.	9
<b>VD110</b>	23,75	Mt.	3
<b>TUBO VD ECO RIGIDO</b>			
<b>VD16ECO</b>	0,52	Mt.	111
<b>VD20ECO</b>	0,80	Mt.	111
<b>VD25ECO</b>	1,40	Mt.	57
<b>CURVAS PARA TUBO RIGIDO VD</b>			
<b>C-16VD</b>	0.483	Un	50
<b>C-20VD</b>	0.609	Un	50
<b>C-25VD</b>	0.914	Un	20
<b>C-32VD</b>	1.439	Un	5
<b>C-40VD</b>	1.995	Un	5
<b>C-50VD</b>	3.266	Un	3
<b>MANGUITOS PARA TUBO RIGIDO VD</b>			
<b>U406-VD12</b>	0.100	Un	50
<b>U407-VD16</b>	0,116	Un	50
<b>U408-VD20</b>	0,196	Un	50
<b>U409-VD25</b>	0,323	Un	25
<b>U410-VD32</b>	0,408	Un	25
<b>U411-VD40</b>	0,531	Un	10
<b>U412-VD50</b>	0,700	Un	5
<b>U413-VD63</b>	1,605	Un	5
<b>MUELLES PARA TUBO RIGIDO VD</b>			
<b>M012</b>	3,48	Un	1
<b>M016</b>	6,98	Un	1
<b>M020</b>	8,16	Un	1
<b>M025</b>	10,43	Un	1
<b>M032</b>	13,23	Un	1
<b>M040</b>	21,39	Un	1
<b>M050</b>	53,48	Un	1
<b>M063</b>	68,36	Un	1



HF

## TUBO VD | FLH

Ref.	Precio Tab. Uni.	Unid. Med.	Cant. Mín. Prov.
VD16FLH	2,27	Mt.	111
VD20FLH	2,79	Mt.	111
VD25FLH	3,59	Mt.	57
VD32FLH	4,94	Mt.	57
VD40FLH	7,50	Mt.	30
VD50FLH	10,19	Mt.	15
VD63FLH	11,97	Mt.	15

## TUBO VD | MLH

VD16MLH	2,10	Mt.	111
VD20MLH	2,52	Mt.	111
VD25MLH	3,15	Mt.	57

## TUBO VD | LLH

VD16LLH	1,79	Mt.	111
VD20LLH	2,10	Mt.	111
VD25LLH	2,68	Mt.	57
VD32LLH	4,62	Mt.	57

## TERMINALES PARA TUBO RIGIDO VD LH

EC16	0,04	Un	100
EC20	0,05	Un	100
EC25	0,06	Un	50

## MANGUITOS PARA TUBO RIGIDO VD LH

U407-VD16LH	0.147	Un	50
U408-VD20LH	0,252	Un	50
U409-VD25LH	0,420	Un	25
U410-VD32LH	0,557	Un	25
U411-VD40LH	0,662	Un	10
U412-VD50LH	0,903	Un	5
U413-VD63LH	1.985	Un	5

## CURVAS PARA TUBO RIGIDO VD LH

C-16VDLH	0,620	Un	50
C-20VDLH	0.756	Un	50
C-25VDLH	1.145	Un	20
C-32VDLH	1.817	Un	5
C-40VDLH	2.510	Un	5
C-50VDLH	4.116	Un	3

## BOQUILLAS PARA TUBO RIGIDO VD LH

284-VD12	0,09	Un	100
285-VD16	0,11	Un	100
286-VD20	0,12	Un	100
287-VD-25	0,13	Un	100

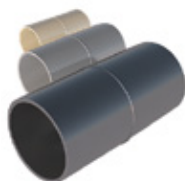



HF

## TUBO CORRUGADO RETARDANTE DE CHAMA CON GUIA LIBRE DE HALÓGENOS

Ref.	Precio Tab. Uni.	Unid. Med.	Cant. Mín. Prov.
<b>JSRLH16G</b>	0,78	Mt.	100
<b>JSRLH20G</b>	0,88	Mt.	100
<b>JSRLH25G</b>	1,16	Mt.	50
<b>JSRLH32G</b>	1,66	Mt.	50
<b>JSRLH40G</b>	2,64	Mt.	50

## TUBO JOTAGRIS "ERM" LH

<b>ERM16</b>	0,81	Mt.	100
<b>ERM20</b>	1,42	Mt.	100
<b>ERM25</b>	2,52	Mt.	100
<b>ERM32</b>	2,94	Mt.	100
<b>ERM40</b>	4,52	Mt.	100



## TUBO JOTAGRIS "ERM" CON GUIA

<b>ERM16G</b>	0,98	Mt.	100
<b>ERM20G</b>	1,55	Mt.	100
<b>ERM25G</b>	2,63	Mt.	100
<b>ERM32G</b>	3,10	Mt.	100
<b>ERM40G</b>	4,65	Mt.	100



## TUBO JOTAGRIS "ERFE" LH

<b>ERFE16</b>	0,42	Mt.	100
<b>ERFE20</b>	0,75	Mt.	100
<b>ERFE25</b>	1,32	Mt.	50
<b>ERFE32</b>	1,54	Mt.	50
<b>ERFE40</b>	2,37	Mt.	50



## TUBO JOTAGRIS "ERFE" CON GUIA LH

<b>ERFE16G</b>	0,51	Mt.	100
<b>ERFE20G</b>	0,83	Mt.	100
<b>ERFE25G</b>	1,38	Mt.	50
<b>ERFE32G</b>	1,62	Mt.	50
<b>ERFE40G</b>	2,45	Mt.	50



## MANGUITOS PARA TUBO JOTAGRIS ERM Y ERFE



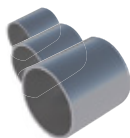

<b>U16</b>	0,21	Un	100
<b>U20</b>	0,30	Un	100
<b>U25</b>	0,42	Un	100

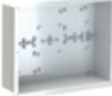

## BOQUILLAS PARA TUBO JOTAGRIS ERM Y ERFE LH

<b>B16</b>	0,189	Un	100
<b>B20</b>	0,210	Un	100
<b>B25</b>	0,300	Un	50



Descripción	Ref.	Precio Tab. Uni.	Unid. Med.	Cant. Mín. Prov.
<b>ATI'S MATRIX COM REPARTIDORES CAT6</b>				
Fondo - Caja De Empotrar ATI De 4 A 16 Salidas	71GN   71G	21,00	Un	1
 KIT'S ATI: Painel + Marco + Tapa				
Panel+Marco Y Tapa ATI Equipados - 4 Salidas (Cat6)	K671GR - 4	188,12	Un	1
Panel+Marco Y Tapa ATI Equipados - 6 Salidas (Cat6)	K671GR - 6	205,12	Un	1
Panel+Marco Y Tapa ATI Equipados - 8 Salidas (Cat6)	K671GR - 8	221,60	Un	1
Panel+Marco Y Tapa ATI Equipados - 10 Salidas (Cat6)	K671GR - 10	355,24	Un	1
Panel+Marco Y Tapa ATI Equipados - 12 Salidas (Cat6)	K671GR - 12	368,24	Un	1
Panel+Marco Y Tapa ATI Equipados - 14 Salidas (Cat6)	K671GR - 14	381,72	Un	1
Panel+Marco Y Tapa ATI Equipados - 16 Salidas (Cat6)	K671GR - 16	391,20	Un	1
<b>ATI'S MATRIX CON REPARTIDORES CAT6 EMPOTRAR COMPLETO</b>				
ATI Empotrar De 4 Salidas (Cat6)	C671GR - 4	209,12	Un	1
ATI Empotrar De 6 Salidas (Cat6)	C671GR - 6	243,12	Un	1
 ATI Empotrar De 8 Salidas (Cat6)	C671GR - 8	258,60	Un	1
ATI Empotrar De 10 Salidas (Cat6)	C671GR - 10	392,24	Un	1
ATI Empotrar De 12 Salidas (Cat6)	C671GR - 12	405,24	Un	1
ATI Empotrar De 14 Salidas (Cat6)	C671GR - 14	418,72	Un	1
ATI Empotrar De 16 Salidas (Cat6)	C671GR - 16	428,20	Un	1
<b>KIT'S REGISTRO DE TERMINACIÓN DE RED ITED 2 Y 3 (Panel + Marco + Tapa)</b>				
Panel+Marco Y Tapa Ati Equipados - 4 Salidas (Cat6)	K971GR - 4	175,12	Un	1
Panel+Marco Y Tapa Ati Equipados - 6 Salidas (Cat6)	K971GR - 6	188,12	Un	1
Panel+Marco Y Tapa Ati Equipados - 8 Salidas (Cat6)	K971GR - 8	195,60	Un	1
 <b>ATI'S INTERIORES COMPLETOS</b>				
ATI Empotrar De 4 Salidas (Cat6)	C971GR - 4	196,12	Un	1
ATI Empotrar De 6 Salidas (Cat6)	C971GR - 6	209,12	Un	1
ATI Empotrar De 8 Salidas (Cat6)	C971GR - 8	216,60	Un	1
<b>KIT'S REGISTRO DE TERMINACIÓN DE RED ITED 2 Y 3</b>				
Fondo - Caja De Empotrar ATI De 4 A 8 Salidas	71P	12,00	Un	1
<b>PANEL+MARCO Y TAPA ATI EQUIPADOS</b>				
Panel+Marco Y Tapa ATI Equipados - 4 Salidas (Cat6)	K971PR - 4	164,12	Un	1
Panel+Marco Y Tapa ATI Equipados - 6 Salidas (Cat6)	K971PR - 6	178,12	Un	1
Panel+Marco Y Tapa ATI Equipados - 8 Salidas (Cat6)	K971PR - 8	185,60	Un	1
 <b>ATI'S INTERIORES COMPLETOS</b>				
ATI Empotrar De 4 Salidas (Cat6)	C971PR - 4	176,12	Un	1
ATI Empotrar De 6 Salidas (Cat6)	C971PR - 6	190,12	Un	1
ATI Empotrar De 8 Salidas (Cat6)	C971PR - 8	197,60	Un	1
<b>REGISTRO DE TERMINACIÓN DE RED DE SUPERFÍCIE COMPLETOS (CAT6)</b>				
<b>ATI SUPERFÍCIE COMPLETO</b>				
 ATI Superficie De 4 Salidas (Cat6)	S671G - 4	195,00	Un	1
ATI Superficie De 6 Salidas (Cat6)	S671G - 6	237,00	Un	1
ATI Superficie De 8 Salidas (Cat6)	S671G - 8	286,00	Un	1
ATI Superficie De 10 Salidas (Cat6)	S671G - 10	368,00	Un	1
ATI Superficie De 12 Salidas (Cat6)	S671G - 12	416,00	Un	1
ATI Superficie De 14 Salidas (Cat6)	S671G - 14	470,00	Un	1
ATI Superficie De 16 Salidas (Cat6)	S671G - 16	502,00	Un	1

## CAJA DE SUPORTE AL ATI - CATI'S



Caja	CATIP	22,00	Un	1
Caja	CATIG	32,00	Un	1
Caja Soporte Pau De Superficie	CATIS	23,00	Un	1
Fondo Catip Para Pré-Instalación	FCATIP	12,00	Un	1
Fondo Catig Para Pré-Instalación	FCATIG	19,00	Un	1
Marco Y Tapa Para Fondo Catip	KCATIP	10,00	Un	1
Marco Y Tapa Para Fondo Catig	KCATIG	13,00	Un	1



## RIT - RECINTO INTERIOR DE TELECOMUNICACIONES EMPOTRADA

Caja Interior	307-ATE-UNI	276,15	Un	1
Caja Interior	309-ATE-MULTI	140,70	Un	1

## RIT - RECINTO INTERIOR DE TELECOMUNICACIONES SUPERFÍCIE

Caja Exterior	308-ATE-UNI	276,15	Un	1
Caja Exterior	310-ATE-MULTI	140,70	Un	1

## FIBRA ÓPTICA MONOMODO ITU-T G.657 CLASSE LSZH, PRÉ-CONECTORIZADA (Conectorizadas SC/APC-SC/APC)

Pigtail 1.5 Mt De 1 Fibra Monomodo (0.9mm) Conectorizada Sc/Apc	PGT015SM09	2,52	Un	1
Patchcord 1.5 Mt De 1 Fibra Monomodo (2.0mm) Conectorizada Sc/Apc-Sc/Apc	PAC015SM20	4,65	Un	1
Patchcord 1.5 Mt De 2 Fibras Monomodo (3.0mm) Conectorizada Sc/Apc-Sc/Apc	PAC015SM30	9,30	Un	1
Patchcord 12 Mt De 2 Fibras Monomodo (3.0mm) Conectorizada Sc/Apc-Sc/Apc	PAC120SM30	14,90	Un	1
Patchcord 18 Mt De 2 Fibras Monomodo (3.0mm) Conectorizada Sc/Apc-Sc/Apc	PAC180SM30	18,10	Un	1
Patchcord 24 Mt De 2 Fibras Monomodo (3.0mm) Conectorizada Sc/Apc-Sc/Apc	PAC240SM30	21,30	Un	1
Patchcord 32 Mt De 2 Fibras Monomodo (3.0mm) Conectorizada Sc/Apc-Sc/Apc	PAC320SM30	25,60	Un	1
Tomada fibra optica de inst. superficie com 25C-APC	TT-FO	8,00	Un	1
RC-FO FBOX	RC-FO	12,21	Un	1

Descripción	Ref.	Dimensiones (mm)	Precio Tab. Uni.	Unid. Med.	Cant. Mín. Prov.
<b>Cajas de entrada multioperador (CAM)   CAJAS CEMU - CAJAS PARA VIVIENDA UNIFAMILIAR</b>					
<b>CAJA PARA RECINTO INTERIOR</b>					
Caja CAM1   CEMU1	295 - CAM1   295 - CEMU1	274 x 324 x 123	35,70	Un	1
Caja CAM2   CEMU2	296 - CAM2   296 - CEMU2	400 x 420 x 155	48,30	Un	1
<b>CAJAS EXTERIORES</b>					
Caja CAM1   CEMU1	297 - CAM1   297 - CEMU1	290 x 330 x 170	43,05	Un	1
Caja CAM2   CEMU2	298 - CAM2   298 - CEMU2	400 x 430 x 170	57,23	Un	1
<b>ATU - REGISTRO BASTIDOR EXTERIOR PARA TELECOMUNICACIONES</b>					
Armario Atu	ATU23U	740x1125x540	3350,00	Un	1
Armario Atu Duplo	ATU2x23U	1340x1125x540	5528,00	Un	1
<b>CAJA ATE - RECINTO DE TELECOMUNICACIONES ITED</b>					
<b>CAJA PARA RECINTO INTERIOR DE TELECOMUNICACIONES ITED</b>					
Caja Interior	292 - ATE2	400 x 420 x 155	48,30	Un	1
Caja Interior	302 - ATE3	500 x 600 x 160	115,50	Un	1
Caja Interior	303 - ATE4	700 x 900 x 160	169,05	Un	1
Caja Interior	304 - ATE5	830 x 900 x 200	260,40	Un	1
Caja Exterior	305 - ATE6	830 x 1070 x 200	309,75	Un	1
<b>CAJA PARA RECINTO EXTERIOR DE TELECOMUNICACIONES ITED</b>					
Caja De Columna Exterior	294 - ATE2	400 x 430 x 170	48,30	Un	1
Caja De Columna Exterior	299 - ATE3	500 x 600 x 160	115,50	Un	1
Caja De Columna Exterior	300 - ATE4	700 x 900 x 160	169,05	Un	1
Caja De Columna Exterior	301 - ATE5	830 x 900 x 200	260,40	Un	1
Caja De Columna Exterior	306 - ATE6	830 x 1070 x 200	309,75	Un	1
Caja De Columna Exterior	311 - ATE7	830 x 1240 x 200	415,80	Un	1
<b>CAJA TIPO C PARA PUNTO DE DISTRIBUCION</b>					
<b>CAJA DE COLUMNA INTERIOR</b>					
Caja De Columna Interior	226 - C0	220 x170 x 105	7,35	Un	1
Caja De Columna Interior	291 - C1	290 x 330 x 170	26,25	Un	1
Caja De Columna Interior	292 - C2	400 x 420 x 155	39,90	Un	1
Caja De Columna Interior	302 - C3	500 x 600 x 160	105,00	Un	1
Caja De Columna Interior	303 - C4	700 x 900 x 160	157,50	Un	1
Caja De Columna Interior	304 - C5	830 x 900 x 200	249,90	Un	1
Caja De Columna Interior	305 - C6	830 x 1070 x 200	298,20	Un	1
<b>CAJA DE COLUMNA EXTERIOR</b>					
Caja De Columna Exterior	226 - C0	220 x170 x 105	7,35	Un	1
Caja De Columna Exterior	293 - C1	290 x 330 x 170	26,25	Un	1
Caja De Columna Exterior	294 - C2	400 x 430 x 170	39,90	Un	1
Caja De Columna Exterior	299 - C3	500 x 600 x 160	105,00	Un	1
Caja De Columna Exterior	300 - C4	700 x 900 x 160	157,50	Un	1
Caja De Columna Exterior	301 - C5	830 x 900 x 200	249,90	Un	1
Caja De Columna Exterior	306 - C6	830 x 1070 x 200	309,75	Un	1



## BASTIDORES

## BASTIDORES DE PISO



Bastidor Rack Suelo 16u	B-05A-16U	600x600x830	359,00	Un	1
Bastidor Rack Suelo 18u	B-05A-18U	600x600x988	383,00	Un	1
Bastidor Rack Suelo 22u	B-05A-22U	600x600x1166	454,00	Un	1
Bastidor Rack Suelo 32u	B-05A-32U	600x600x1610	553,00	Un	1
Bastidor Rack Suelo 42u	B-05A-42U	600x600x2055	674,00	Un	1
Bastidor Rack Suelo 42u	B-068-42U	600x800x2055	1105,00	Un	1
Bastidor Rack Suelo 42u	B-610-42U	600x1000x2055	1339,00	Un	1
Bastidor Rack Suelo 42u	B-088-42U	800x800x2055	1480,00	Un	1
Bastidor Rack Suelo 47u	B-068-47U	600x800x2277	1370,00	Un	1
Bastidor Rack Suelo 47u	B-610-47U	600x1000x2277	1588,00	Un	1

## BASTIDORES DE PARED

Bastidor Rack Pared 6u	B-05FF-6U	600x450x368	167,00	Un	1
Bastidor Rack Pared 9u	B-05FF-9U	600x450x501	204,00	Un	1
Bastidor Ati *	B-ATI	600X450X501	498,00	Un	1
Bastidor Rack Pared 12u	B-05FF-12U	600x450x635	248,00	Un	1
Bastidor Rack Pared 15u	B-05FF-15U	600x450x769	263,00	Un	1
Bastidor Rack Pared Doble Cuerpo 6u	B-02BC-6U	600x450x368	238,00	Un	1
Bastidor Rack Pared Doble Cuerpo 9u	B-02BC-9U	600x550x501	287,00	Un	1
Bastidor Rack Pared Doble Cuerpo 15u	B-02BC-15U	600x550x769	359,00	Un	1

\* **Incluye:** Fan de ventilación y paneles laterales extraíbles, Patch Panel Cat6, Patch Panel Coaxial 16 tomas, Patch Panel con FO BOX, Patch Panel organizador de cables, Adaptadores SC APC, Bloque 6 Tomas schuko, conjuntos de tornillos.

Descripción	Ref.	Precio Tab. Unid.	Unid. Med.	Cant. Min. Prov.
<b>ACCESORIOS DE BASTIDOR</b>				
Placa De Fondo 1u	B-J001	4,66	Un	1
Placa De Fondo 2u	B-J002	8,70	Un	1
Placa De Fondo 3u	B-J003	12,30	Un	1
Placa Pasa Hilos 1ua	B-J004	12,70	Un	1
Placa Pasa Hilos 1ub	B-J005	11,20	Un	1
Placa Pasa Hilos 1uc	B-J006	13,25	Un	1
Placa Escov.P.Hilos 1u	B-J007	14,50	Un	1
Conj.Paraf.Anil.F.Pain	B-J013	0,49	Un	1
Bandeja Extraíble Telescópica Para Rack De 1u	B-J015	64,20	Un	1
Bandeja Simples 1u Fixación Frontal	B-J017-1U	29,50	Un	1
Bandeja Simples 2u Fixación Frontal	B-J017-2U	64,00	Un	1

Descripción	Ref.	Precio Tab. Uni.	Unid. Med.	Cant. Min. Prov.
Panel Ciego 1u	B-J019-1U	4,25	Un	1
Panel Ciego 2u	B-J019-2U	8,60	Un	1
Panel Ciego 3u	B-J019-3U	10,00	Un	1
Panel Ciego 4u	B-J019-4U	12,50	Un	1
Dispositivo Ventilacion	B-J020	13,30	Un	1
Ruedas	B-J021	3,90	Un	1
Pie De Apoyo Regulable	B-J022	2,65	Un	1
Base De Energia .6 Tom.C/Int	B-J023	13,00	Un	1
Base De Energia .6 Tom.C/Int	B-J024	41,00	Un	1
Patch Panel 1u 24 Rj45 Cat5e	B-P004	53,00	Un	1
Patch Panel 2u 48 Rj45 Cat5e	B-P005	79,00	Un	1
Patch Panel 1u 24 Rj45 Cat5e	B-P012	57,00	Un	1
Patch Panel 1u 24 Rj45 Cat5e	B-P016	64,00	Un	1
Patch Panel 1u 24 Rj45 Cat6	B-P018	72,00	Un	1
Patch Panel 1u 24 Rj45 Cat6	B-P019	137,00	Un	1
Patch Panel 2u 48 Rj45 Cat6	B-P020	247,00	Un	1
Patch Panel 1u 24 Rj45 Cat6	B-P021	118,00	Un	1
Patch Panel 2u 48 Rj45 Cat6	B-P022	234,00	Un	1
Placa 1u R.Sin.Coax.	B-P037-8	116,00	Un	1
Placa 1u R.Sin.Coax.	B-P037-16	127,00	Un	1
Placa 1u R.Sin.Coax.	B-P037-24	139,00	Un	1
Painel De Topo Con 4 Fans De Ventilação Para Bastidor De Chão	B-P050	97,50	Un	1
Panel Termostato Digital	B-JG01	147,00	Un	1
Panel Fibra Optic	GPX-4820-4	57,00	Un	1
Panel Fibra Optic	GPX-4820-12	121,00	Un	1
Panel Fibra Optic	GPX-4820-24	126,00	Un	1
Adaptadores Para Fibra Óptica Sc/Apc Simplex	SC-APC SIMP	1,75	Un	1
Empalme Ficha Tipo F (Fêmea - Fêmea) Para Cabo Coaxial	FFF Simples	0,42	Un	1
Tom.Rj45 Tipo Amp	RJ45CAT6	2,00	Un	1
Panel 24 Rj45	B-P008-24RJ45	11,48	Un	1
Panel 24 Sc/Apc	B-P040-24SC	11,48	Un	1
Panel 19" Para alojamiento De 24 Fichas Fêmea Tipo F Paracoaxial (Vazio)	B-P040-24CC	11,48	Un	1
Panel Krone B-J043	B-J043	30,00	Un	1
Panel 24 BP-041-24CC	B-P041-24CC	11,48	Un	1
<b>PTI - PUNTO DE TRANSICIÓN INDIVIDUAL Y PCS - PUNTO DE CONCENTRACIÓN DE SERVICIOS</b>				
Instalação embebida	PTI-I	30,87	Un	1
Instalação saliente	PTI-E	29,09	Un	1
Instalação embebida - 2 saídas	PCS-I2	41,58	Un	1
Instalação embebida - 4 saídas	PCS-I4	58,55	Un	1
Instalação saliente - 2 saídas	PCS-E2	40,00	Un	1
Instalação saliente - 4 saídas	PCS-E4	56,55	Un	1