

Conector sub D 9 H soldar Ecolan

Ref.: 28603.1

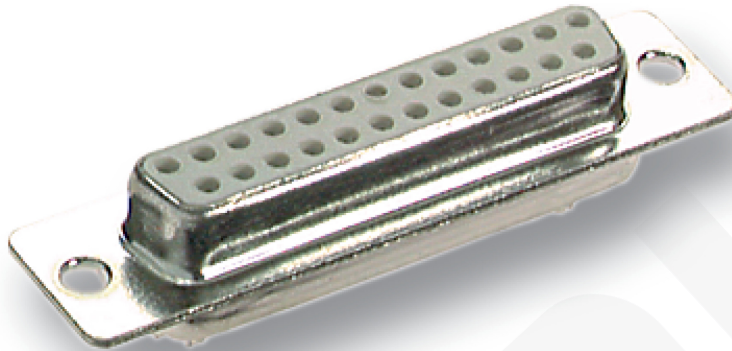

General data

- Tin-plated housin
- Quality level III \geq 50 mating cycle

Allgemeine Daten

Model	jack
Connection type	solder

Elektrische Eigenschaften

Contact type	female
--------------	--------

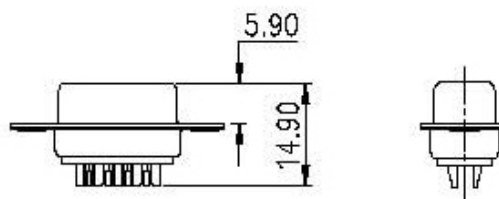
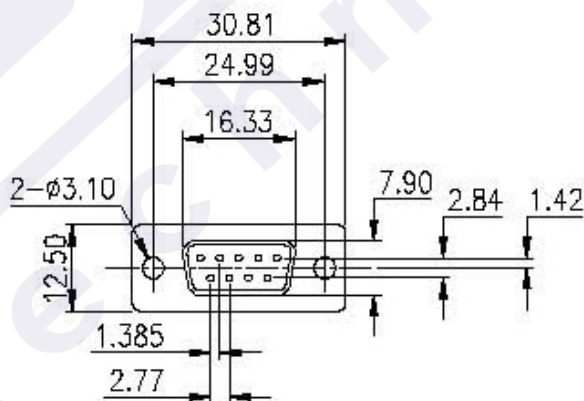

Ideal Technology has a policy of continuous improvement. Specifications are subject to change without notice.