

Carcasa sub D 9 e-dh plástico negro Ecolan

Ref.: 29415.1

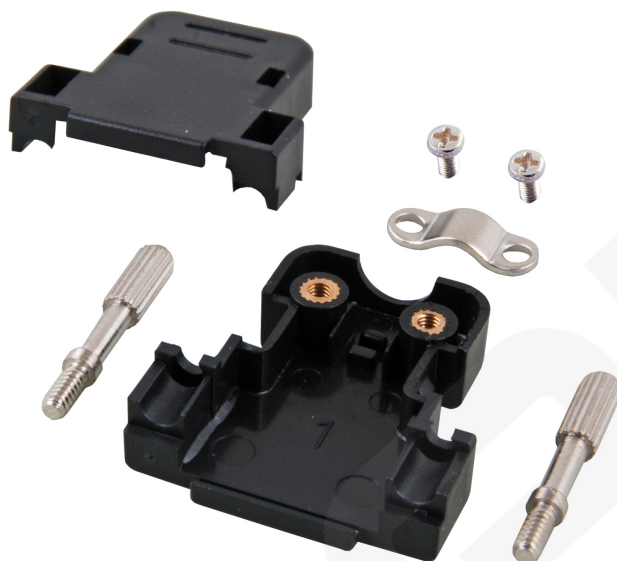

General data

- Plastic housing, incl. thumb screw
- With snap fastene

Allgemeine Daten

Material | Plastic

Mechanische Eigenschaften

Two piece | True

Locking mechanism | Screw

Separable | True

Carcasa sub D 9 e-dh plástico negro Ecolan

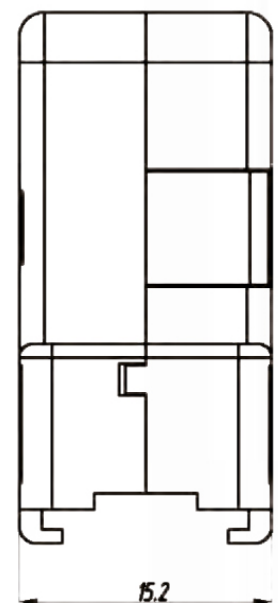
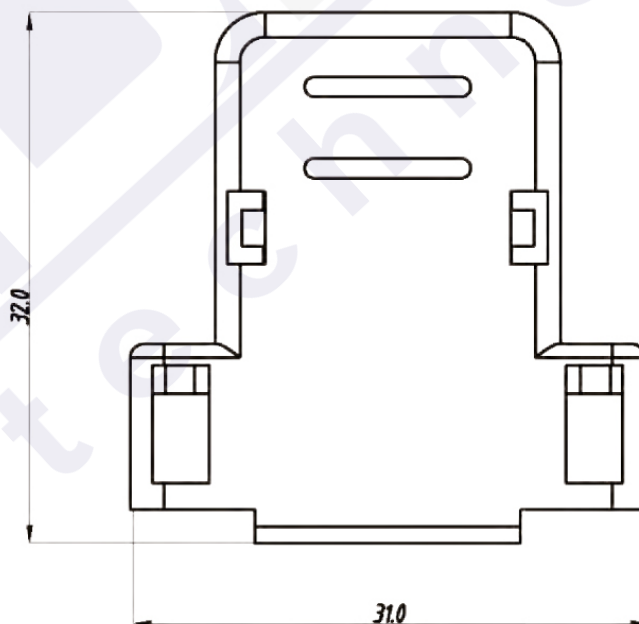
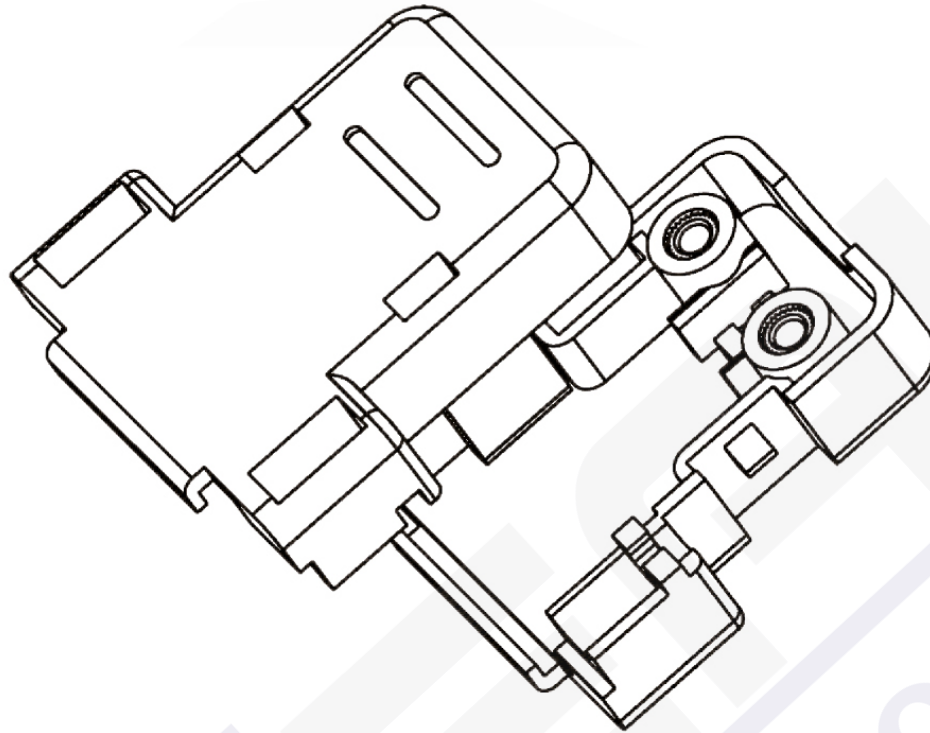

Ideal Technology has a policy of continuous improvement. Specifications are subject to change without notice.